



Sun Fire™ 880 Server Owner's Guide

Sun Microsystems, Inc.
901 San Antonio Road
Palo Alto, CA 94303-4900 U.S.A.
650-960-1300

Part No. 806-6592-11
August 2001 Revision A

Copyright 2001 Sun Microsystems, Inc., 901 San Antonio Road, Palo Alto, CA 94303-4900 U.S.A. All rights reserved.

This product or document is distributed under licenses restricting its use, copying, distribution, and decompilation. No part of this product or document may be reproduced in any form by any means without prior written authorization of Sun and its licensors, if any. Third-party software, including font technology, is copyrighted and licensed from Sun suppliers.

Parts of the product may be derived from Berkeley BSD systems, licensed from the University of California. UNIX is a registered trademark in the U.S. and other countries, exclusively licensed through X/Open Company, Ltd.

Sun, Sun Microsystems, the Sun logo, AnswerBook, AnswerBook2, docs.sun.com, Sun Enterprise, Sun Fire, VIS, Java, OpenBoot, SunSwift, Sun Enterprise SyMON, SunVTS, and Solaris are trademarks, registered trademarks, or service marks of Sun Microsystems, Inc. in the U.S. and other countries. All SPARC trademarks are used under license and are trademarks or registered trademarks of SPARC International, Inc. in the U.S. and other countries. Products bearing SPARC trademarks are based upon an architecture developed by Sun Microsystems, Inc.

The OPEN LOOK and Sun™ Graphical User Interface was developed by Sun Microsystems, Inc. for its users and licensees. Sun acknowledges the pioneering efforts of Xerox in researching and developing the concept of visual or graphical user interfaces for the computer industry. Sun holds a non-exclusive license from Xerox to the Xerox Graphical User Interface, which license also covers Sun's licensees who implement OPEN LOOK GUIs and otherwise comply with Sun's written license agreements.

Federal Acquisitions: Commercial Software—Government Users Subject to Standard License Terms and Conditions.

DOCUMENTATION IS PROVIDED "AS IS" AND ALL EXPRESS OR IMPLIED CONDITIONS, REPRESENTATIONS AND WARRANTIES, INCLUDING ANY IMPLIED WARRANTY OF MERCHANTABILITY, FITNESS FOR A PARTICULAR PURPOSE OR NON-INFRINGEMENT, ARE DISCLAIMED, EXCEPT TO THE EXTENT THAT SUCH DISCLAIMERS ARE HELD TO BE LEGALLY INVALID.

Copyright 2001 Sun Microsystems, Inc., 901 San Antonio Road, Palo Alto, CA 94303-4900 Etats-Unis. Tous droits réservés.

Ce produit ou document est distribué avec des licences qui en restreignent l'utilisation, la copie, la distribution, et la décompilation. Aucune partie de ce produit ou document ne peut être reproduite sous aucune forme, par quelque moyen que ce soit, sans l'autorisation préalable et écrite de Sun et de ses bailleurs de licence, s'il y en a. Le logiciel détenu par des tiers, et qui comprend la technologie relative aux polices de caractères, est protégé par un copyright et licencié par des fournisseurs de Sun.

Des parties de ce produit pourront être dérivées des systèmes Berkeley BSD licenciés par l'Université de Californie. UNIX est une marque déposée aux Etats-Unis et dans d'autres pays et licenciée exclusivement par X/Open Company, Ltd.

Sun, Sun Microsystems, le logo Sun, AnswerBook, AnswerBook2, docs.sun.com, Sun Enterprise, Sun Fire, VIS, Java, OpenBoot, SunSwift, Sun Enterprise SyMON, SunVTS, et Solaris sont des marques de fabrique ou des marques déposées, ou marques de service, de Sun Microsystems, Inc. aux Etats-Unis et dans d'autres pays. Toutes les marques SPARC sont utilisées sous licence et sont des marques de fabrique ou des marques déposées de SPARC International, Inc. aux Etats-Unis et dans d'autres pays. Les produits portant les marques SPARC sont basés sur une architecture développée par Sun Microsystems, Inc.

L'interface d'utilisation graphique OPEN LOOK et Sun™ a été développée par Sun Microsystems, Inc. pour ses utilisateurs et licenciés. Sun reconnaît les efforts de pionniers de Xerox pour la recherche et le développement du concept des interfaces d'utilisation visuelle ou graphique pour l'industrie de l'informatique. Sun détient une licence non exclusive de Xerox sur l'interface d'utilisation graphique Xerox, cette licence couvrant également les licenciés de Sun qui mettent en place l'interface d'utilisation graphique OPEN LOOK et qui en outre se conforment aux licences écrites de Sun.

LA DOCUMENTATION EST FOURNIE "EN L'ETAT" ET TOUTES AUTRES CONDITIONS, DECLARATIONS ET GARANTIES EXPRESSES OU TACITES SONT FORMELLEMENT EXCLUES, DANS LA MESURE AUTORISEE PAR LA LOI APPLICABLE, Y COMPRIS NOTAMMENT TOUTE GARANTIE IMPLICITE RELATIVE A LA QUALITE MARCHANDE, A L'APTITUDE A UNE UTILISATION PARTICULIERE OU A L'ABSENCE DE CONTREFAÇON.



Regulatory Compliance Statements

Your Sun product is marked to indicate its compliance class:

- Federal Communications Commission (FCC) — USA
- Industry Canada Equipment Standard for Digital Equipment (ICES-003) — Canada
- Voluntary Control Council for Interference (VCCI) — Japan
- Bureau of Standards Metrology and Inspection (BSMI) — Taiwan

Please read the appropriate section that corresponds to the marking on your Sun product before attempting to install the product.



For important safety precautions to follow when installing or servicing this system, please see “Safety Precautions” on page 201.

FCC Class A Notice

This device complies with Part 15 of the FCC Rules. Operation is subject to the following two conditions:

1. This device may not cause harmful interference.
2. This device must accept any interference received, including interference that may cause undesired operation.

Note: This equipment has been tested and found to comply with the limits for a Class A digital device, pursuant to Part 15 of the FCC Rules. These limits are designed to provide reasonable protection against harmful interference when the equipment is operated in a commercial environment. This equipment generates, uses, and can radiate radio frequency energy, and if it is not installed and used in accordance with the instruction manual, it may cause harmful interference to radio communications. Operation of this equipment in a residential area is likely to cause harmful interference, in which case the user will be required to correct the interference at his own expense.

Shielded Cables: Connections between the workstation and peripherals must be made using shielded cables to comply with FCC radio frequency emission limits. Networking connections can be made using unshielded twisted-pair (UTP) cables.

Modifications: Any modifications made to this device that are not approved by Sun Microsystems, Inc. may void the authority granted to the user by the FCC to operate this equipment.

FCC Class B Notice

This device complies with Part 15 of the FCC Rules. Operation is subject to the following two conditions:

1. This device may not cause harmful interference.
2. This device must accept any interference received, including interference that may cause undesired operation.

Note: This equipment has been tested and found to comply with the limits for a Class B digital device, pursuant to Part 15 of the FCC Rules. These limits are designed to provide reasonable protection against harmful interference in a residential installation. This equipment generates, uses and can radiate radio frequency energy and, if not installed and used in accordance with the instructions, may cause harmful interference to radio communications. However, there is no guarantee that interference will not occur in a particular installation. If this equipment does cause harmful interference to radio or television reception, which can be determined by turning the equipment off and on, the user is encouraged to try to correct the interference by one or more of the following measures:

- Reorient or relocate the receiving antenna.
- Increase the separation between the equipment and receiver.
- Connect the equipment into an outlet on a circuit different from that to which the receiver is connected.
- Consult the dealer or an experienced radio/television technician for help.

Shielded Cables: Connections between the workstation and peripherals must be made using shielded cables in order to maintain compliance with FCC radio frequency emission limits. Networking connections can be made using unshielded twisted pair (UTP) cables.

Modifications: Any modifications made to this device that are not approved by Sun Microsystems, Inc. may void the authority granted to the user by the FCC to operate this equipment.

ICES-003 Class A Notice - Avis NMB-003, Classe A

This Class A digital apparatus complies with Canadian ICES-003.

Cet appareil numérique de la classe A est conforme à la norme NMB-003 du Canada.

ICES-003 Class B Notice - Avis NMB-003, Classe B

This Class B digital apparatus complies with Canadian ICES-003.

Cet appareil numérique de la classe B est conforme à la norme NMB-003 du Canada.

VCCI 基準について

クラス A VCCI 基準について

クラス A VCCI の表示があるワークステーションおよびオプション製品は、クラス A 情報技術装置です。これらの製品には、下記の項目が該当します。

この装置は、情報処理装置等電波障害自主規制協議会 (VCCI) の基準に基づくクラス A 情報技術装置です。この装置を家庭環境で使用すると電波妨害を引き起こすことがあります。この場合には使用者が適切な対策を講ずるよう要求されることがあります。

クラス B VCCI 基準について

クラス B VCCI の表示  があるワークステーションおよびオプション製品は、クラス B 情報技術装置です。これらの製品には、下記の項目が該当します。

この装置は、情報処理装置等電波障害自主規制協議会 (VCCI) の基準に基づくクラス B 情報技術装置です。この装置は、家庭環境で使用することを目的としていますが、この装置がラジオやテレビジョン受信機に近接して使用されると、受信障害を引き起こすことがあります。取扱説明書に従って正しい取り扱いをしてください。

BSMI Class A Notice

The following statement is applicable to products shipped to Taiwan and marked as Class A on the product compliance label.

警告使用者：
這是甲類的資訊產品，在居住的環境中使用時，可能會造成射頻干擾，在這種情況下，使用者會被要求採取某些適當的對策。

Declaration of Conformity

Compliance Model Number: 880
Product Family Name: Sun Fire 880

EMC

European Union

This equipment complies with the following requirements of the EMC Directive 89/336/EEC:

EN55022:1998/CISPR22:1997	Class A
EN55024:1998	Required Limits (as applicable):
EN61000-4-2	4 kV (Direct), 8 kV (Air)
EN61000-4-3	3 V/m
EN61000-4-4	1.0 kV AC Power Lines, 0.5 kV Signal and DC Power Lines
EN61000-4-5	1 kV AC Line-Line and Outdoor Signal Lines 2 kV AC Line-Gnd, 0.5 kV DC Power Lines
EN61000-4-6	3 V
EN61000-4-8	1 A/m
EN61000-4-11	Pass
EN61000-3-2:1995 + A1, A2, A14	Pass
EN61000-3-3:1995	Pass

Safety

This equipment complies with the following requirements of the Low Voltage Directive 73/23/EEC:

EC Type Examination Certificates:

EN60950:1992, 2nd Edition, Amendments 1, 2, 3, 4, 11 TÜV Rheinland Certificate No. S2071517.01
IEC 950:1991, 2nd Edition, Amendments 1, 2, 3, 4 CB Scheme Certificate No. US/5013/UL
Evaluated to all CB Countries

Supplementary Information

This product was tested and complies with all the requirements for the CE Mark.

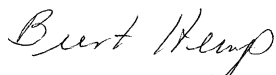

Burt Hemp
Manager, Product Compliance

May 5, 2001

Sun Microsystems, Inc.
One Network Drive
Burlington, MA 01803
USA

Tel: 781-442-0006
Fax: 781-442-1673



Peter J. Arkless
Quality Manager

May 5, 2001

Sun Microsystems Scotland, Limited
Springfield, Linlithgow
West Lothian, EH49 7LR
Scotland, United Kingdom

Tel: 1506-670000
Fax: 1506-672323

Contents

Preface xv

1. System Overview 1

About the Sun Fire 880 Server 2

Locating Front Panel Features 6

Locating Rear Panel Features 8

About the Status and Control Panel 10

About Reliability, Availability, and Serviceability Features 14

2. Setting Up the System 23

About the Parts Shipped to You 24

How to Install the Sun Fire 880 Server 25

How to Open the Side Doors 29

How to Avoid Electrostatic Discharge 31

How to Install a Disk Drive 33

How to Remove a Disk Drive 36

How to Install a Power Supply 39

How to Remove a Power Supply 42

About Setting Up a Console 45

How to Attach an Alphanumeric Terminal 46

How to Configure a Local Graphics Console	48
How to Power On the System	51
How to Power Off the System	53
How to Initiate a Reconfiguration Boot	55
How to Redirect the System Console to RSC	58
How to Restore the Local System Console	60
3. Hardware Configuration	61
About CPU/Memory Boards	62
About Memory Modules	64
About PCI Cards and Buses	68
About the Remote System Control Card	71
About Power Supplies	73
About Fan Trays	75
About Removable Media Devices	78
About the Serial Ports	79
About the USB Ports	80
About Hardware Jumpers	81
About Serial Port Jumpers	82
About Flash PROM Jumpers	83
4. Mass Storage Subsystem Configuration	89
About FC-AL Technology	90
About Sun Fire 880 Mass Storage Features	92
About the Mass Storage Subsystem Components	94
About the FC-AL Disk Backplanes	95
About Internal Disk Drives	97
About FC-AL Host Adapters	99
About FC-AL Device Addresses	101

- 5. Configuring Network Interfaces 103**
 - About Network Interface Options 104
 - About Redundant Network Interfaces 105
 - How to Configure the Primary Network Interface 106
 - How to Configure Additional Network Interfaces 108
 - How to Attach a Fiber-Optic Gigabit Ethernet Cable 112
 - How to Attach a Twisted-Pair Ethernet Cable 114
 - How to Select the Boot Device 116

- 6. Configuring System Firmware 119**
 - About OpenBoot Environmental Monitoring 120
 - How to Enable OpenBoot Environmental Monitoring 122
 - How to Disable OpenBoot Environmental Monitoring 123
 - How to Obtain OpenBoot Environmental Status Information 124
 - About Automatic System Recovery 126
 - How to Enable ASR 130
 - How to Disable ASR 131
 - How to Deconfigure a Device Manually 132
 - How to Reconfigure a Device Manually 134
 - How to Obtain ASR Status Information 136
 - About OpenBoot Emergency Procedures 138

- 7. Server Administration 141**
 - About Server Administration Software 142
 - About Hot-Pluggable and Hot-Swappable Components 144
 - About Multipathing Software 148
 - About Sun Management Center Software 149
 - About Sun Remote System Control Software 150
 - About Volume Management Software 152

	About the Solaris luxadm Utility	156
	About Sun Cluster Software	157
8.	LED Status Indicators	159
	About CPU/Memory Slot LEDs	160
	About PCI Slot LEDs	161
	About Power Supply LEDs	163
	About Fan Tray LEDs	164
	About Disk Drive LEDs	166
	About the Gigabit Ethernet LEDs	168
9.	Using Removable Media Storage Devices	169
	About the DVD-ROM Drive	170
	How to Insert a CD or DVD Into the Drive	171
	How to Eject a CD or DVD With Software Commands	173
	How to Eject a CD or DVD Manually	175
	How to Eject a CD or DVD in an Emergency	177
	How to Clean a CD or DVD	179
	About Tape Drives and Tape Cartridges	181
	How to Insert a Tape Cartridge	182
	How to Remove a Tape Cartridge	183
	How to Control a Tape Drive	184
	How to Clean a Tape Drive	185
A.	Connector Pinouts	187
	Reference for Serial Port A and B Connectors	188
	Reference for the USB Connectors	189
	Reference for the Twisted-Pair Ethernet Connector	190
	Reference for the RSC Ethernet Connector	191

Reference for the RSC Modem Connector 192

Reference for the RSC Serial Connector 193

B. System Specifications 195

Reference for Physical Specifications 196

Reference for Electrical Specifications 196

Reference for Environmental Requirements 197

Reference for Agency Compliance Specifications 198

Reference for Clearance and Service Access Specifications 198

C. Safety Precautions 201

Preface

The *Sun Fire 880 Server Owner's Guide* answers your questions about setting up and running the Sun Fire™ 880 server. Features and options, system setup and installation, hardware configuration, and system administration topics for the Sun Fire 880 server are covered in this manual.

This manual presents information in a modular format designed to answer the type of questions that you might ask while installing, configuring, and using the Sun Fire 880 server. Look at the titles of the modules and you'll find the cue words that direct you to the categories of questions and answers, such as:

- How to . . . How do I do something?
- About . . . Is there more information about this topic?
- Reference for . . . Where can I find reference material for something?

You determine how much or how little of the information you need to read.

Using the table of contents or the task list on the first page of each chapter, you can quickly find a specific topic or task. The information modules are brief; however, they are interrelated and refer to other modules that you may want to read. For instance, if you're installing a disk drive and you're already familiar with the task, you could go to "How to Install a Disk Drive" and follow the installation procedure. But if you need more background information before performing the task, you should first read "About Internal Disk Drives."

Using UNIX Commands

This document might not contain information on basic UNIX[®] commands and procedures such as shutting down the system, booting the system, and configuring devices. See one or more of the following for this information:

- *Solaris Handbook for Sun Peripherals*
- AnswerBook2[™] online documentation for the Solaris[™] operating environment

Typographic Conventions

Typeface	Meaning	Examples
AaBbCc123	The names of commands, files, and directories; on-screen computer output	Edit your <code>.login</code> file. Use <code>ls -a</code> to list all files. % You have mail.
AaBbCc123	What you type, when contrasted with on-screen computer output	% su Password:
<i>AaBbCc123</i>	Book titles, new words or terms, words to be emphasized	Read Chapter 6 in the <i>User's Guide</i> . These are called <i>class</i> options. You <i>must</i> be superuser to do this.
<code>AaBbCc123</code>	Command-line variable; replace with a real name or value	To delete a file, type <code>rm filename</code> .

Shell Prompts

Shell	Prompt
C shell	<i>machine-name%</i>
C shell superuser	<i>machine-name#</i>
Bourne shell and Korn shell	\$
Bourne shell and Korn shell superuser	#

Related Documentation

Application	Title
Installation	<i>Sun Fire 880 Server Rackmounting Guide</i>
	<i>Installation Instructions for Solaris</i>
	<i>Solaris (SPARC Platform Edition) Installation Guide</i>
	<i>Solaris (SPARC Platform Edition) Installation Release Notes</i>
	<i>Solaris Sun Hardware Platform Guide</i>
	<i>Solaris Installation Guide</i>
<i>Solaris Advanced Installation Guide</i>	
Service	<i>Sun Fire 880 Server Service Manual</i>
Late-Breaking Information	<i>Sun Fire 880 Server Product Notes</i>
	<i>Solaris Release Notes</i>
	<i>Solaris Release Notes Supplement for Sun Hardware</i>
System Diagnostics	<i>SunVTS User's Guide</i>
	<i>SunVTS Test Reference Manual</i>
	<i>SunVTS Quick Reference Card</i>
System Management	<i>Sun Management Center Software Installation Guide</i>
	<i>Sun Management Center Software User's Guide</i>
	<i>Sun Management Center Supplement for Workgroup Servers</i>
	<i>Sun Management Center Software Release Notes</i>
System Administration	<i>Solaris System Administrator AnswerBook</i>
	<i>Platform Notes: The eri FastEthernet Device Driver</i>
	<i>Platform Notes: The Sun GigabitEthernet Device Driver</i>
	<i>Platform Notes: Using luxadm Software</i>
	<i>Sun Fire 880 Dynamic Reconfiguration User's Guide</i>
	<i>OpenBoot Command Reference Manual</i>
<i>OpenBoot Quick Reference</i>	
Remote System Monitoring and Control	<i>Sun Remote System Control (RSC) User's Guide</i>

Accessing Sun Documentation Online

A broad selection of Sun system documentation is located at:

<http://www.sun.com/products-n-solutions/hardware/docs>

A complete set of Solaris documentation and many other titles are located at:

<http://docs.sun.com>

Ordering Sun Documentation

Fatbrain.com, an Internet professional bookstore, stocks select product documentation from Sun Microsystems, Inc.

For a list of documents and how to order them, visit the Sun Documentation Center on Fatbrain.com at:

<http://www.fatbrain.com/documentation/sun>

Sun Welcomes Your Comments

Sun is interested in improving its documentation and welcomes your comments and suggestions. You can email your comments to Sun at:

docfeedback@sun.com

Please include the part number (806-6592-11) of your document in the subject line of your email.

System Overview

This chapter introduces you to the Sun Fire 880 server and describes some of its features. The following information is covered in this chapter:

- “About the Sun Fire 880 Server” on page 2
- “Locating Front Panel Features” on page 6
- “Locating Rear Panel Features” on page 8
- “About the Status and Control Panel” on page 10
- “About Reliability, Availability, and Serviceability Features” on page 14

About the Sun Fire 880 Server

The Sun Fire 880 server is a high-performance, shared memory, symmetric multiprocessing server system that supports up to eight Sun UltraSPARC™ III processors. The UltraSPARC III processor implements the SPARC V9 Instruction Set Architecture (ISA) and the Visual Instruction Set (VIS™) extensions that accelerate multimedia, networking, encryption, and Java™ processing.

The system is housed in a roll-around tower enclosure, which measures 28.1 inches high, 18.9 inches wide, and 32.9 inches deep (71.4 cm x 48.0 cm x 83.6 cm). The system has a maximum weight of 288 lb (130.6 kg).

Processing power is provided by up to four CPU/Memory boards. Each board incorporates:

- Two UltraSPARC III processors
- 8 Mbytes of local static random access memory (SRAM) external cache memory per processor
- Slots for up to 16 memory modules (eight per processor)

A fully configured system includes a total of eight UltraSPARC III CPUs residing on four CPU/Memory boards. For more information, see “About CPU/Memory Boards” on page 62.

System main memory is provided by up to 64 next generation dual inline memory modules (DIMMs), which operate at a 75-MHz clock frequency. The system supports 128-, 256-, and 512-Mbyte DIMMs, with future support for higher capacities as they become available. Total system memory is shared by all CPUs in the system and ranges from a minimum of 1 Gbyte (one CPU/Memory board with eight 128-Mbyte DIMMs) to a maximum of 32 Gbytes (four boards fully populated with 512-Mbyte DIMMs). For more information about system memory, see “About Memory Modules” on page 64.

System I/O is handled by four separate Peripheral Component Interconnect (PCI) buses. These industry-standard buses support all of the system’s on-board I/O controllers in addition to nine slots for PCI interface cards. Seven of the PCI slots operate at a 33-MHz clock rate, and two slots operate at either 33 or 66 MHz. All slots comply with PCI Local Bus Specification Revision 2.1 and support PCI hot-plug operations. You can hot-plug any standard PCI card, provided a suitable software driver exists for the Solaris operating environment and the driver supports PCI hot-plug operations. For additional details, see “About PCI Cards and Buses” on page 68.

Internal disk storage is provided by up to 12 hot-pluggable, dual-ported Fibre Channel-Arbitrated Loop (FC-AL) disk drives. The basic system includes a single FC-AL disk backplane that accommodates up to six disks. An optional expansion backplane can be added to accommodate an additional six drives.

Both backplanes provide dual-loop access to each of the FC-AL disk drives. One loop is controlled by an on-board FC-AL controller integrated into the system motherboard. The second loop is controlled by a PCI FC-AL host adapter card (available as a system option). This dual-loop configuration enables simultaneous access to internal storage via two different controllers, which increases available I/O bandwidth to 200 Mbytes per second (versus 100 Mbytes per second for single-loop configurations). A dual-loop configuration can also be combined with multipathing software to provide hardware redundancy and failover capability. Should a component failure render one loop inaccessible, the software can automatically switch data traffic to the second loop to maintain system availability. For more information about the system's internal disk array, see "Mass Storage Subsystem Configuration" on page 89.

External multidisk storage subsystems and redundant array of independent disks (RAID) storage arrays can be supported by installing single-channel or multichannel PCI host adapter cards along with the appropriate system software. Software drivers supporting SCSI, FC-AL, and other types of devices are included in the Solaris operating environment.

The Sun Fire 880 server provides front panel access to three mounting bays for 5.25-inch half-height (1.6-inch) removable media devices. One of the bays houses a SCSI DVD-ROM drive, which comes standard in all system configurations. The other two bays can be used for wide (68-pin) or narrow (50-pin) SCSI tape drives, such as 8-mm tape drives or 4-mm DDS-2 or DDS-3 tape drives. You can easily convert the two bays into a single full-height bay by removing a metal shelf divider. The SCSI bus that supports the removable media devices is Fast/Wide-capable (20 Mbytes per second) and can support single-ended wide or narrow SCSI devices. For additional details, see "About Removable Media Devices" on page 78.

The system provides two on-board Ethernet interfaces—one Gigabit Ethernet and one Fast Ethernet interface. The Gigabit Ethernet interface operates at 1000 megabits per second (Mbps). The Fast Ethernet interface can operate at 10 or 100 Mbps and negotiates automatically with the remote end of the link (the link partner) to select a common mode of operation.

Additional Ethernet interfaces or connections to other network types can be provided by installing the appropriate PCI interface cards. Multiple network interfaces can be combined with multipathing software to provide hardware redundancy and failover capability. Should one of the interfaces fail, the software can automatically switch all network traffic to an alternate interface to maintain network availability. For more information about network connections, see "Configuring Network Interfaces" on page 103.

The Sun Fire 880 server provides two serial communication ports, which are accessed through a single, shared DB-25 connector located on the system rear panel. The primary port is capable of both synchronous and asynchronous communication, while the secondary port is asynchronous only. An optional serial port splitter cable is required to access the secondary serial port. For more information, see “About the Serial Ports” on page 79.

The rear panel also provides two Universal Serial Bus (USB) ports for connecting USB peripheral devices such as modems, printers, scanners, digital cameras, or a Sun Type 6 USB keyboard and mouse. The USB ports support both isochronous mode and asynchronous mode and enable data transmission at speeds of 1.5 and 12 Mbps. For additional details, see “About the USB Ports” on page 80.

The local system console device can be either a standard ASCII character terminal or a local graphics console. The ASCII terminal connects to one of the system’s two serial ports, while a local graphics console requires installation of a PCI graphics card, monitor, USB keyboard, and mouse. You can also administer the system from a remote workstation connected to the Ethernet or from a Sun Remote System Control (RSC) console.

RSC is a secure server management tool that lets you monitor and control your server over modem lines or over a network. RSC provides remote system administration for geographically distributed or physically inaccessible systems. RSC software works in conjunction with the RSC card included in all Sun Fire 880 servers. The RSC card runs independently of the host server, and operates off of 5-volt standby power from the system’s power supplies. The card also includes a battery that provides approximately 30 minutes of backup power in the event of a power failure. Together these features allow RSC to serve as a “lights out” management tool that continues to function even when the server operating system goes offline, the server is powered off, or a power outage occurs.

Using RSC software, you can:

- Access Solaris and OpenBoot PROM console functions remotely via the modem, serial, and Ethernet ports on the RSC card
- Run power-on self-test (POST) and OpenBoot Diagnostics from a remote console
- Remotely monitor server environmental conditions, such as fan, temperature, and power supply status, even when the server is offline
- Receive notification of server problems via email or pager, even in the event of a power failure
- Perform remote server reboot, power-on, and power-off functions on demand

For additional details, see “About the Remote System Control Card” on page 71 and “About Sun Remote System Control Software” on page 150.

The basic system includes two 1120-watt power supplies with internal fans. Two power supplies provide sufficient power for a maximally configured system. An optional third power supply can be added to provide N + 1 redundancy, allowing

the system to continue operating should any one of the power supplies fail. Power supplies in a redundant configuration are hot-swappable, so that you can remove and replace a faulty power supply without shutting down the operating system or turning off the system power. For more information about the power supplies, see “About Power Supplies” on page 73.

The Sun Fire 880 server can be installed in any standard Electronic Industries Association (EIA) 310-compliant 19-inch (48.3 cm) rack with at least 17 rack units (29.8 inches, 75.6 cm) of available vertical mounting space and sufficient load-bearing capacity. An optional rackmounting kit is available for installing the server into racks with depths ranging from 32 inches (81.3 cm) to 36 inches (91.4 cm). Instructions for rackmounting the server are supplied with the rackmounting kit.

System reliability, availability, and serviceability are enhanced by features that include:

- Hot-pluggable disk drives and PCI cards
- Hot-swappable power supplies and fan tray assemblies
- Easy access to all internal replaceable components
- Support for disk and network multipathing with automatic failover capability
- Support for RAID 0, 1, 0+1, 1+0, and 5 implementations
- Thermal sensing and overtemperature protection
- Power system monitoring and fault protection
- Remote “lights out” management capability
- N+1 power supply redundancy
- Automatic system recovery (ASR) capabilities
- Four levels of system diagnostics
- Front panel status indicator lights
- Internal diagnostic LED indicators
- Error-correcting code on all memory and data paths
- Parity checking on all system address buses

Locating Front Panel Features

The illustration below shows the system features that are accessible from the front panel with the front door open.

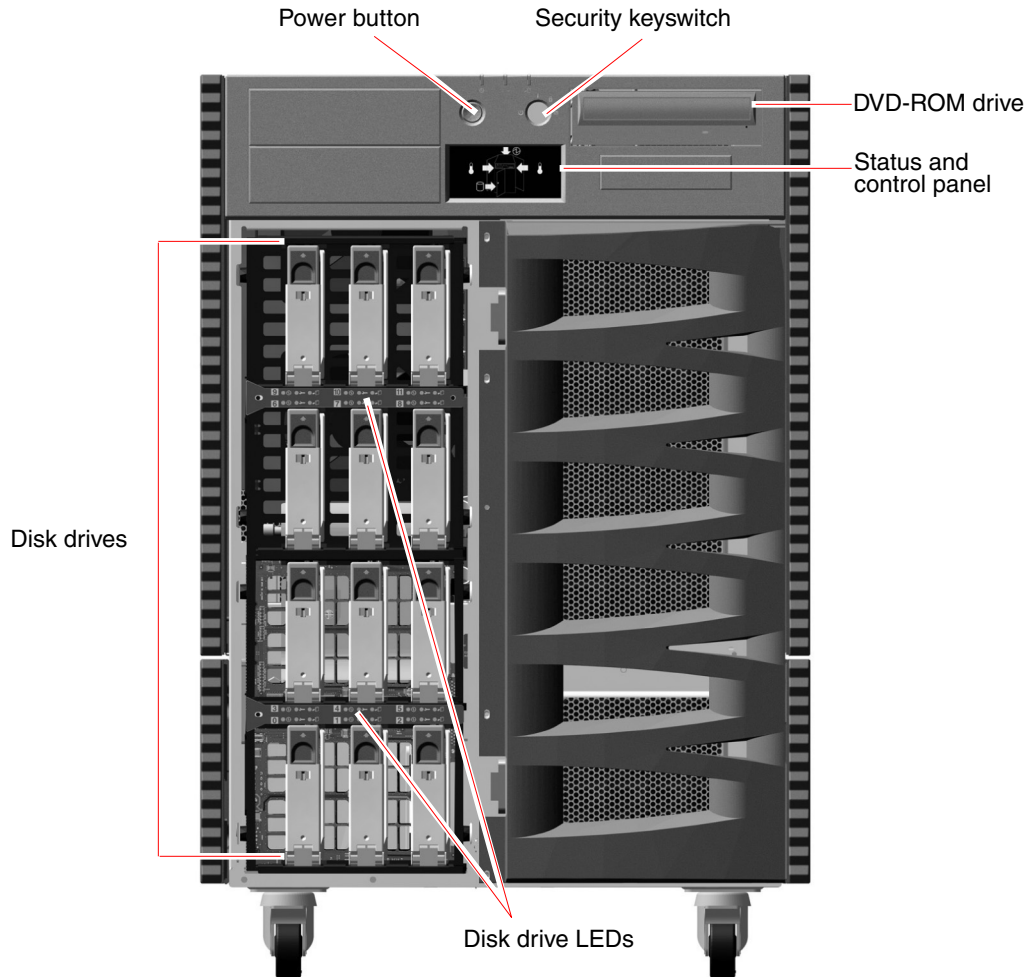

For information about front panel controls and indicators, see “About the Status and Control Panel” on page 10.

Access to the system's internal disk drives is through a large hinged door at the front of the system. The front door features a keylock for added security. When the key is in the horizontal position, the door is unlocked. Make sure that the key is in the horizontal position before you close the door. To prevent unauthorized access to the disk drives, lock the door by turning the key 90 degrees counterclockwise and remove the key.

Note – The same key operates the front panel keyswitch and the locks on the front and side doors.

Locating Rear Panel Features

The following figure shows the system features that are accessible from the rear panel.

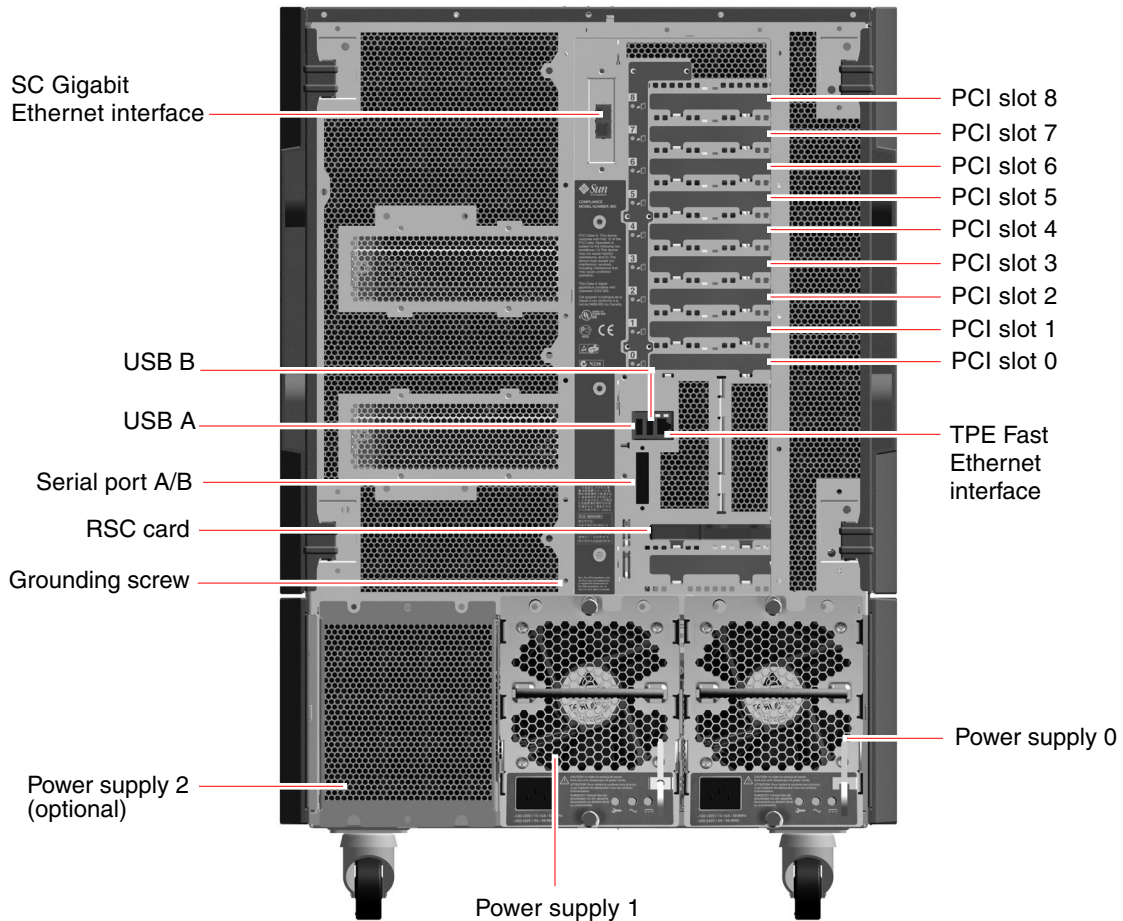

You can configure the system with two or three power supplies, which are accessible from the system rear panel. Each power supply has three LED indicators for displaying power status and fault conditions. See “About Power Supply LEDs” on page 163 for additional details.

A grounding screw is located just above the center power supply. When installing a Sun Fire 880 server into a rack, or connecting the server to an external storage array, be sure to connect an appropriate grounding strap between the server’s grounding screw and the grounding screw on the rack enclosure or external storage array. A grounding strap prevents ground loops between systems and peripherals and helps guard against possible data loss.

About the Status and Control Panel

The system status and control panel includes several LED status indicators, a Power button, and a security keyswitch. The following figure shows the status and control panel.

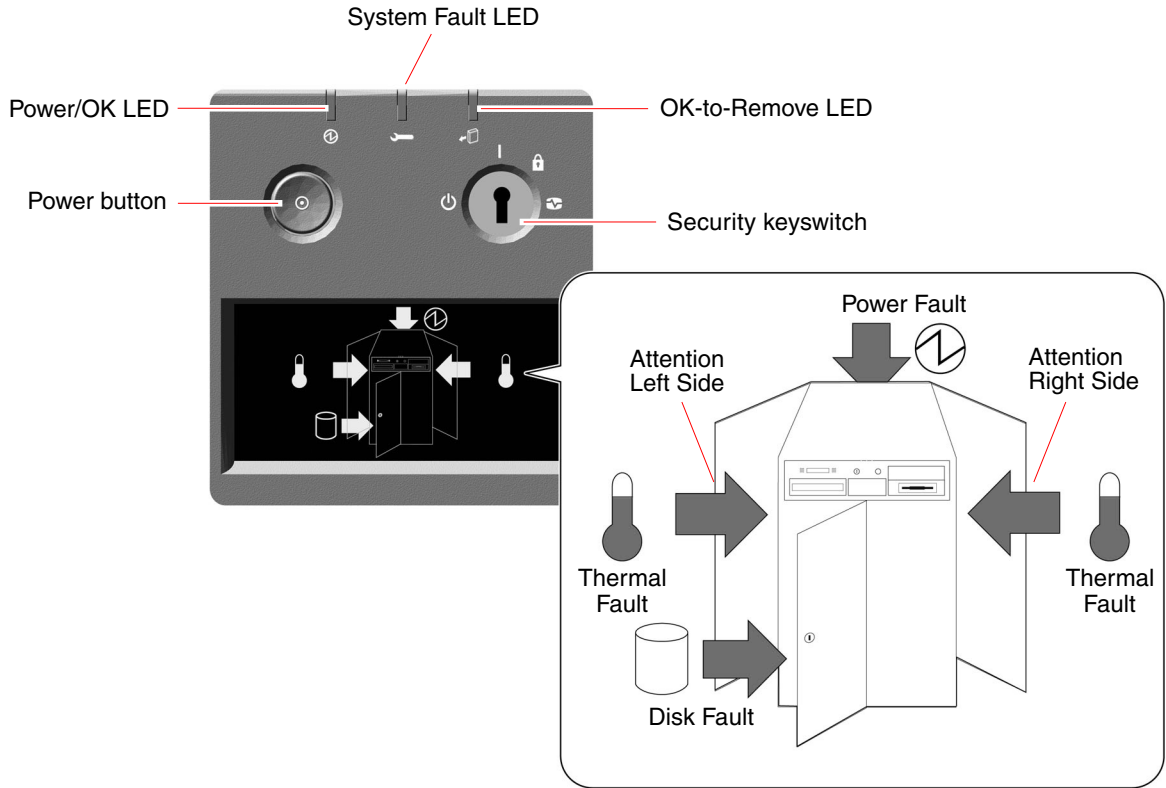





LED Status Indicators





Several LED status indicators provide general system status, alert you to system problems, and help you to determine the location of system faults:

- At the top of the status and control panel, three general status LEDs provide a snapshot of the system status.
- Below the Power button and security keyswitch, a graphical display provides additional LED icons to indicate specific fault conditions and locations.

The general status LEDs work in conjunction with the specific fault LED icons. For example, a fault in the disk subsystem illuminates both the System Fault LED at the top of the panel and the Disk Fault icon in the graphical display below it. Fault LEDs within the enclosure help pinpoint the location of the faulty device. Since all front panel status LEDs are powered by the system's 5-volt standby power source, fault LEDs remain lit for any fault condition that results in a system shutdown. For more information about LED indicators on the rear panel and inside the enclosure, see "LED Status Indicators" on page 159.

During system startup, the front panel LEDs are individually toggled on and off to verify that each one is working correctly. After that, the front panel LEDs operate as described in the following table.

Name	Icon	Description
Power/OK		This green LED lights when the system power is on.
System Fault		This amber LED lights to indicate a serious system fault. When this LED is lit, one or more icons in the display panel may also light to indicate the specific nature and location of the fault.
OK-to-Remove		This amber LED lights to indicate that an internal hot-pluggable component is ready for removal.
Disk Fault		This amber LED lights to indicate a serious disk subsystem fault that is likely to bring down the system. When this LED is lit, one or more disk LEDs may also be lit at the front of the disk cage, indicating the source of the fault. See "About Disk Drive LEDs" on page 166.

Name	Icon	Description
Power Fault		This amber LED lights to indicate a serious power subsystem fault that is likely to bring down the system. When this LED is lit, one or more power supply LEDs may also be lit on the system rear panel. See “About Power Supply LEDs” on page 163.
Thermal Fault		This amber LED lights to indicate a serious thermal fault (fan fault or overtemperature condition) that is likely to bring down the system. There are two Thermal Fault LEDs in the display to indicate whether the fault is located on the left or right side of the system. In the event of a fan fault, a fault LED inside the system will indicate the faulty fan assembly. See “About Fan Tray LEDs” on page 164.
Attention Left Side		This amber LED lights to indicate that an internal component on the left side of the system requires servicing.
Attention Right Side		This amber LED lights to indicate that an internal component on the right side of the system requires servicing.

Power Button





The system Power button is recessed to prevent accidentally turning the system on or off. The ability of the Power button to turn the system on or off is controlled by the security keyswitch.

If the operating system is running, pressing and releasing the Power button initiates a graceful software system shutdown. Pressing and holding in the Power button for five seconds causes an immediate hardware shutdown.

Note – Whenever possible, you should use the graceful shutdown method. Forcing an immediate hardware shutdown may cause disk drive corruption and loss of data. Use this method only as a last resort.

Security Keyswitch

The four-position security keyswitch controls the power-on modes of the system and prevents unauthorized users from powering off the system or reprogramming system firmware. The following table describes the function of each keyswitch setting.

Position	Icon	Description
Normal		This setting enables the system Power button to power the system on or off. If the operating system is running, pressing and releasing the Power button initiates a graceful software system shutdown. Pressing and holding the Power button in for five seconds causes an immediate hardware power off.
Locked		<p>The Locked setting:</p> <ul style="list-style-type: none">• Disables the system Power button to prevent unauthorized users from powering the system on or off• Disables the keyboard Stop-a command, terminal Break key command, ~# tip window command, and RSC break command, preventing users from suspending system operation to access the system ok prompt• Prevents unauthorized programming of the system flash PROMs <p>The Locked position is the recommended setting for normal day-to-day operations.</p>
Diagnostics		This setting forces the power-on self-test (POST) and OpenBoot™ Diagnostics to run during system startup. The Power button functions the same as when the keyswitch is in the Normal position.
Forced Off		<p>This setting forces the system to power off immediately and enter 5-volt standby mode. It also disables the system Power button. You may want to use this setting when AC power is interrupted and you do not want the system to restart automatically when power is restored. With the keyswitch in any other position, if the system was running prior to losing power, it restarts automatically once power is restored.</p> <p>The Forced Off setting also prevents an RSC console from restarting the system. However, the RSC card continues to operate using the system's 5-volt standby power.</p>

About Reliability, Availability, and Serviceability Features

Reliability, availability, and serviceability are aspects of a system's design that affect its ability to operate continuously and minimize the time necessary to service the system. Reliability refers to a system's ability to operate continuously without failures and to maintain data integrity. System availability refers to the percentage of time that a system remains accessible and usable. Serviceability relates to the time it takes to restore a system to service following a system failure. Together, reliability, availability, and serviceability features provide for near continuous system operation.

To deliver high levels of reliability, availability and serviceability, the Sun Fire 880 system offers the following features:

- Hot-pluggable disk drives and PCI cards
- N+1 power supply redundancy
- Hot-swappable power supplies
- Redundant, hot-swappable fan trays
- Environmental monitoring and fault protection
- Automatic system recovery (ASR) capabilities
- Hardware watchdog mechanism
- Remote System Control (RSC) remote "lights out" management capability
- Support for disk and network multipathing with automatic failover capability
- Dual-loop enabled FC-AL mass storage subsystem
- Support for RAID 0, 1, 0+1, 1+0, and 5 storage configurations
- Error correction and parity checking for improved data integrity
- Easy access to all internal replaceable components
- Easily accessible LED status indicators
- Four different levels of system diagnostics

Hot-Pluggable Disk Drives and PCI Cards

Sun Fire 880 system hardware is designed to support hot-plugging of internal disk drives and PCI cards. With the proper software support, you can install or remove these components while the system is running. Hot-plug technology significantly increases the system's serviceability and availability, by providing the ability to:

- Increase storage, and I/O capacity dynamically to handle larger work loads and improve system performance
- Replace disk drives and PCI cards without service disruption

You can hot-plug any standard PCI card, provided a suitable software driver exists for the Solaris operating environment, and the driver supports PCI hot-plug operations. In addition, the card must comply with the PCI Hot-Plug Specification Revision 1.1, and the system must be running the Solaris 8 7/01 operating environment or a subsequent release that supports Sun Fire 880 PCI hot-plug operations.

PCI hot-plug procedures may involve software commands for preparing the system prior to removing a card and for reconfiguring the operating environment after installing a PCI card. For more information about PCI hot-plug procedures, see "About Hot-Pluggable and Hot-Swappable Components" on page 144.



Caution – Do not attempt to hot-plug a PCI card until you are certain that its device drivers support PCI hot-plug operations; otherwise, you may cause a system panic. For a list of Sun PCI cards and device drivers that support PCI hot-plug operations, see the *Sun Fire 880 Server Product Notes*.

For additional information about the system's hot-pluggable components, see "About Hot-Pluggable and Hot-Swappable Components" on page 144.

N+1 Power Supply Redundancy

The system can accommodate up to three power supplies. All system configurations require a minimum of two power supplies. An optional third supply can be used to provide N+1 redundancy, allowing the system to continue operating should one of the power supplies fail.

For more information about power supplies, redundancy, and configuration rules, see "About Power Supplies" on page 73.

Hot-Swappable Power Supplies

Power supplies in a redundant configuration feature a “hot-swap” capability. You can remove and replace a faulty power supply without shutting down the operating system. The power supplies are easily accessed from the rear of the system, without the need to remove system covers.

Redundant, Hot-Swappable Fan Trays

The basic system configuration includes three primary fan tray assemblies to provide system cooling. Systems equipped with the redundant cooling option include three secondary fan trays for protection against cooling failures. Only the primary fan trays are active during normal system operation. If a primary fan tray fails, the environmental monitoring subsystem detects the failure and automatically activates the appropriate secondary fan tray.

All fan trays feature a hot-swap capability. You can remove and replace a faulty fan tray without shutting down the operating system. For additional details, see “About Fan Trays” on page 75.

Environmental Monitoring and Control

The Sun Fire 880 system features an environmental monitoring subsystem designed to protect against:

- Extreme temperatures
- Lack of adequate air flow through the system
- Power supply problems

Monitoring and control capabilities reside at the operating system level as well as in the system’s flash PROM firmware. This ensures that monitoring capabilities remain operational even if the system has halted or is unable to boot.

The environmental monitoring subsystem uses an industry standard I²C bus. The I²C bus is a simple two-wire serial bus, used throughout the system to allow the monitoring and control of temperature sensors, fans, power supplies, status LEDs, and the front panel keyswitch.

Temperature sensors are located throughout the system to monitor the ambient temperature of the system and the temperature of each CPU. The monitoring subsystem frequently polls each sensor and uses the sampled temperatures to report and respond to any overtemperature or undertemperature conditions.

The hardware and software together ensure that the temperatures within the enclosure do not stray outside predetermined “safe operation” ranges. If the temperature observed by a sensor falls below a low-temperature warning threshold or rises above a high-temperature warning threshold, the monitoring subsystem software generates a WARNING message to the system console. If the temperature exceeds a low- or high-temperature critical threshold, the software will issue a CRITICAL message and proceed to gracefully shut down the system. In both cases, the System Fault and Thermal Fault LEDs on the front status panel are illuminated to indicate the nature of the problem.

This thermal shutdown capability is also built into the hardware circuitry as a fail-safe measure. This feature provides backup thermal protection in the unlikely event that the environmental monitoring subsystem becomes disabled at both the software and firmware levels.

All error and warning messages are displayed on the system console (if one is attached) and are logged in the `/var/adm/messages` file. Front panel fault LEDs remain lit after an automatic system shutdown to aid in problem diagnosis.

The monitoring subsystem is also designed to detect fan failures. The basic system features three primary fan trays, which include a total of five individual fans. Systems equipped with the redundant cooling option include three additional (secondary) fan trays for a total of 10 individual fans. During normal operation, only the five primary fans are active. If any fan fails, the monitoring subsystem detects the failure and:

- Generates an error message and logs it in the `/var/adm/messages` file
- Lights the System Fault and Thermal Fault LEDs on the status and control panel
- Lights the appropriate fan fault LED inside the system
- Automatically activates the appropriate secondary fan tray (if installed)

The power subsystem is monitored in a similar fashion. The monitoring subsystem periodically polls the power supply status registers for a power supply OK status, indicating the status of each supply’s 3.3V, 5.0V, 12V, and 48V DC outputs.

If a power supply problem is detected, an error message is displayed on the system console and logged in the `/var/adm/messages` file. The System Fault and Power Fault LEDs on the status and control panel are also lit. LEDs located on the back of each power supply will indicate the source and nature of the fault.

For more information about error messages generated by the environmental monitoring subsystem, see the *Sun Fire 880 Server Service Manual*. For more information about system LEDs, see Chapter 8.

Automatic System Recovery

The system provides for automatic system recovery (ASR) from the following types of hardware component failures:

- CPUs
- Memory modules
- PCI buses and cards
- SCSI bus
- FC-AL subsystem
- Fast Ethernet interface
- Gigabit Ethernet interface
- USB interface
- Serial interfaces

The automatic system recovery feature allows the system to resume operation after experiencing certain non-fatal hardware faults or failures. Automatic self-test features enable the system to detect failed hardware components and an auto-configuring capability designed into the system's boot firmware allows the system to deconfigure failed components and restore system operation. As long as the system is capable of operating without the failed component, the ASR features will enable the system to reboot automatically, without operator intervention.

During the power-on sequence, if a faulty component is detected, the component is effectively disabled and, if the system remains capable of functioning, the boot sequence continues. In a running system, some types of failures (such as a processor failure) can bring the system down. If this happens, the ASR functionality enables the system to reboot immediately if it is possible for the system to function without the failed component. This prevents a faulty hardware component from keeping the entire system down or causing the system to crash repeatedly.

Note – The ASR feature is not enabled until you activate it. Control over the system's ASR functionality is provided by a number of OpenBoot PROM commands and configuration variables. For additional details, see Chapter 6.

Hardware Watchdog Mechanism

To detect and respond to system hang conditions, the Sun Fire 880 system features a hardware watchdog mechanism—a hardware timer that is continually reset as long as the operating system is running. In the event of a system hang, the operating system is no longer able to reset the timer. The timer will then expire and cause an automatic system reset, eliminating the need for operator intervention.

Note – The hardware watchdog mechanism is not activated until you enable it.

To enable this feature, you must edit the `/etc/system` file to include the following entry:

```
set watchdog_enable = 1
```

This change does not take effect until you reboot the system.

Remote System Control (RSC)

Remote System Control (RSC) software is a secure server management tool that lets you monitor and control your server over modem lines or over a network. RSC provides remote system administration for geographically distributed or physically inaccessible systems. The RSC software works with the RSC card on the Sun Fire 880 system I/O board. The RSC card provides modem and private Ethernet connections to a remote console, and a serial connection to a local alphanumeric terminal.

Once RSC is configured to manage your server, you can use it to run diagnostic tests, view diagnostic and error messages, reboot your server, and display environmental status information from a remote console. If the operating system is down, RSC can send an email or pager alert about power failures, hardware failures, or other important events that may be occurring on your server.

RSC provides the following features:

- Remote system monitoring and error reporting (including diagnostic output)
- Remote reboot, power-on, and power-off functions
- Ability to monitor system environmental conditions remotely
- Ability to run diagnostic tests from a remote console
- Remote event notification for overtemperature conditions, power supply failures, fatal system errors, or system crashes
- Remote access to detailed event logs
- Remote console functions via modem, Ethernet, or serial port

For additional details, see “About the Remote System Control Card” on page 71 and “About Sun Remote System Control Software” on page 150.

Dual-Loop Enabled FC-AL Mass Storage Subsystem

The system's dual-ported FC-AL disk drives and dual-loop enabled backplanes may be combined with an optional PCI FC-AL host adapter card to provide for fault tolerance and high availability of data. This dual-loop configuration allows each disk drive to be accessed through two separate and distinct data paths, providing:

- *Increased bandwidth* – Allowing data transfer rates up to 200 Mbytes per second versus 100 Mbytes per second for single-loop configurations
- *Hardware redundancy* – Providing the ability to sustain component failures in one path by switching all data transfers to an alternate path

The mass storage subsystem is described in greater detail in Chapter 4.

Support for RAID Storage Configurations

Using a software RAID application such as Solstice DiskSuite™ or VERITAS Volume Manager, you can configure system disk storage in a variety of different RAID levels. Configuration options include RAID 0 (striping), RAID 1 (mirroring), RAID 0+1 (striping plus mirroring), RAID 1+0 (mirroring plus striping), and RAID 5 configurations (striping with interleaved parity). You choose the appropriate RAID configuration based on the price, performance, and reliability/availability goals for your system. You can also configure one or more drives to serve as “hot spares” to fill in automatically for a defective drive in the event of a disk failure.

For more information, see “About Volume Management Software” on page 152.

Error Correction and Parity Checking

Error-correcting code (ECC) is used on all internal system data paths to ensure high levels of data integrity. All data that moves between processors, memory, and PCI bridge chips have end-to-end ECC protection.

The system reports and logs correctable ECC errors. A correctable ECC error is any single-bit error in a 128-bit field. Such errors are corrected as soon as they are detected. The ECC implementation can also detect double-bit errors in the same 128-bit field and multiple-bit errors in the same nibble (4 bits).

In addition to providing ECC protection for data, the system offers parity protection on all system address buses. Parity protection is also used on the PCI and SCSI buses, and in the UltraSPARC CPU's internal and external cache.

Status LEDs

The system provides easily accessible light-emitting diode (LED) indicators to provide a visual indication of system and component status. LEDs are located on the system front panel, internal disk bays, power supplies, fan tray assemblies, and near each CPU/Memory board and PCI slot. Status LEDs eliminate guesswork and simplify problem diagnosis for enhanced serviceability.

Front panel status LEDs are described in “About the Status and Control Panel” on page 10. For details on the system internal LEDs, see Chapter 8.

Four Levels of Diagnostics

For enhanced serviceability and availability, the system provides four different levels of diagnostic testing:

- Power-on self-test (POST)
- OpenBoot Diagnostics
- Sun Validation Test Suite (SunVTS™)
- Sun Management Center system monitoring and management software (formerly known as Sun Enterprise SyMON™ software)

POST and OpenBoot Diagnostics are firmware-resident diagnostics that can run even if the server is unable to boot the operating system. POST diagnostics provide a quick but thorough check of the most basic hardware functions of the system. OpenBoot Diagnostics provide a more comprehensive test of the system, including external interfaces.

Application-level diagnostics, such as SunVTS and Sun Management Center software, offer additional troubleshooting capabilities once the operating system is running. Like OpenBoot Diagnostics, SunVTS software provides a comprehensive test of the system, including its external interfaces. SunVTS software also lets you run tests remotely over a network connection or from an RSC console. Sun Management Center software provides a variety of continuous system monitoring capabilities. It enables you to monitor system hardware status and operating system performance of your server. For more information about diagnostic tools, see the *Sun Fire 880 Server Service Manual*.

Setting Up the System

This chapter describes what you need to do to get the Sun Fire 880 server up and running. Where software is involved, this chapter explains some of what you need to do, and points you to the appropriate software manuals for the rest.

Tasks covered in this chapter include:

- “How to Install the Sun Fire 880 Server” on page 25
- “How to Open the Side Doors” on page 29
- “How to Avoid Electrostatic Discharge” on page 31
- “How to Install a Disk Drive” on page 33
- “How to Remove a Disk Drive” on page 36
- “How to Install a Power Supply” on page 39
- “How to Remove a Power Supply” on page 42
- “How to Attach an Alphanumeric Terminal” on page 46
- “How to Configure a Local Graphics Console” on page 48
- “How to Power On the System” on page 51
- “How to Power Off the System” on page 53
- “How to Initiate a Reconfiguration Boot” on page 55
- “How to Redirect the System Console to RSC” on page 58
- “How to Restore the Local System Console” on page 60

Other information covered in this chapter includes:

- “About the Parts Shipped to You” on page 24
- “About Setting Up a Console” on page 45

About the Parts Shipped to You

Sun Fire 880 systems are “configured-to-order,” which means that most internal options are pre-installed at the factory. However, if you ordered options that are not factory-installed (such as a monitor), these will be shipped to you separately.

In addition, you should have received the media and documentation for all appropriate system software. Check that you have received everything you ordered.

Note – Inspect all shipping cartons for evidence of physical damage. If a shipping carton is damaged, request that the carrier's agent be present when the carton is opened. Keep all contents and packing material for the agent's inspection.

Unpacking instructions are printed on the outside of the shipping carton.

How to Install the Sun Fire 880 Server

Before You Begin

The Sun Fire 880 server is a general-purpose server, which you can use for many types of applications. Exactly how you set up your machine depends on what you want it to do.

This procedure is intended to be as “generic” as possible, so as to cover the needs of most sites. Even so, you will need to make certain decisions to complete the procedure:

- On which network or networks do you intend your machine to operate?

For background information about network support, see “About Network Interface Options” on page 104.

- How do you want to configure and use your system’s internal storage array?

For background information about internal storage array configuration options, see “Mass Storage Subsystem Configuration” on page 89.

- What software do you intend to load?

Software included in the Solaris media kit or other software products may impose certain disk space or disk partitioning requirements. Refer to the documentation accompanying this software to determine those requirements.

Once you have answered these questions, you are ready to begin.

What to Do

1. **Verify that you have received all the parts of your system.**

See “About the Parts Shipped to You” on page 24.

2. **Connect an AC power cord to the power inlet at the rear of each power supply. Connect the opposite end of each power cord to a grounded, dedicated AC power outlet.**

Note – You must connect each power supply to a dedicated AC circuit. Consult your local electrical codes for any additional requirements.

Insert the female end of the power cord through the releasable tie-wrap loop located to the right of the supply. Tighten the tie-wrap to secure the connection.

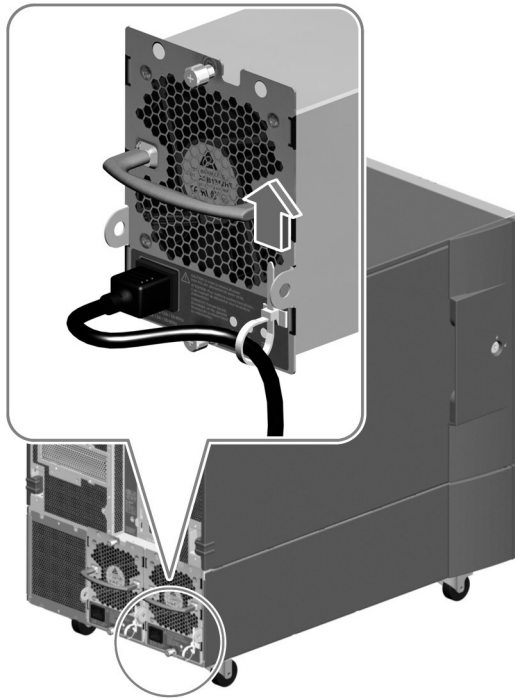

3. Install any optional components shipped with your system.

Many of the options that you ordered with your system are pre-installed at the factory. However, if you ordered options that are not factory-installed, see the following sections for installation instructions:

- "How to Install a Disk Drive" on page 33
- "How to Install a Power Supply" on page 39

Note – All internal options (except disk drives and power supplies) must be installed only by qualified service personnel. Installation procedures for these components are covered in the *Sun Fire 880 Server Service Manual*, which is included on the Sun Fire 880 Documentation CD.

Note – The AC power cords provide a discharge path for static electricity, so they must remain plugged in to AC power outlets when installing or handling any internal component, *except for the RSC card*. Prior to servicing the RSC card, make sure that all AC power cords are disconnected.

4. If necessary, configure the serial port jumpers and connect any serial peripheral devices.

Two serial port jumpers located on the system I/O board are used to configure the system's serial ports to operate in compliance with the Electronics Industries Association EIA-423 or EIA-232D standards. The jumpers are factory-set for the EIA-423 standard, which is the default standard for North American users. Compliance with the EIA-232D standard is required for digital telecommunication in nations of the European Community. If you require EIA-232D compliance, see the following sections for configuration instructions:

- “How to Open the Side Doors” on page 29
- “How to Avoid Electrostatic Discharge” on page 31
- “About Serial Port Jumpers” on page 82

For information about serial port characteristics, see “About the Serial Ports” on page 79.

Note – All internal jumper modifications must be performed only by qualified service personnel.

5. Set up a console for your server.

You must set up a console in order to install the Solaris operating environment and any application software. You can attach an ASCII terminal or graphics console to your system, or establish a `tip` connection from another Sun system. For more information, see “About Setting Up a Console” on page 45.

6. Prepare the network interface(s).

The Sun Fire 880 server provides two on-board Ethernet interfaces as part of the standard configuration—one Fast Ethernet interface and one Gigabit Ethernet interface. A variety of supported PCI cards can provide connections to additional Ethernet or other network types. For details about network interface options and configuration procedures, see the following sections:

- “About Network Interface Options” on page 104
- “How to Configure the Primary Network Interface” on page 106
- “How to Configure Additional Network Interfaces” on page 108

7. Turn on power to your server.

See “How to Power On the System” on page 51. For information about the LED status indicators that appear during power-up, see “About the Status and Control Panel” on page 10.

8. Install and boot the Solaris operating environment software.

See the installation instructions provided with your Solaris software. You should also consult the *Solaris on Sun Hardware Platform Guide*, which contains platform-specific information about software installation.

9. Set any desired OpenBoot PROM configuration options.

You can control several aspects of system behavior through OpenBoot PROM commands and configuration variables. For additional details, see “Configuring System Firmware” on page 119.

10. Load additional desired software from the Solaris media kit.

The Solaris media kit (shipped separately) includes several CDs containing software to help you operate, configure, and administer your server. See the documentation provided with the Solaris media kit for a complete listing of included software and detailed installation instructions.

11. Load online documentation from the Sun Fire 880 Documentation CD.

You can copy the CD contents to a local or network disk drive, or view the documentation directly from the CD. See the installation instructions that accompany the CD in the Sun Fire 880 documentation set.

12. Install and configure Remote System Control (RSC) software from the Solaris media kit.

Sun RSC software is included on the Computer Systems Supplement CD for your specific Solaris release. For installation instructions, see the *Solaris Sun Hardware Platform Guide* provided in the Solaris media kit. For information about configuring and using RSC, see the *Sun Remote System Control (RSC) User's Guide* provided with the RSC software.

Note – Once you install RSC software, you can configure the system to use RSC as the system console. For detailed instructions, see “How to Redirect the System Console to RSC” on page 58.

How to Open the Side Doors

What to Do

1. Use the system key to unlock the door.

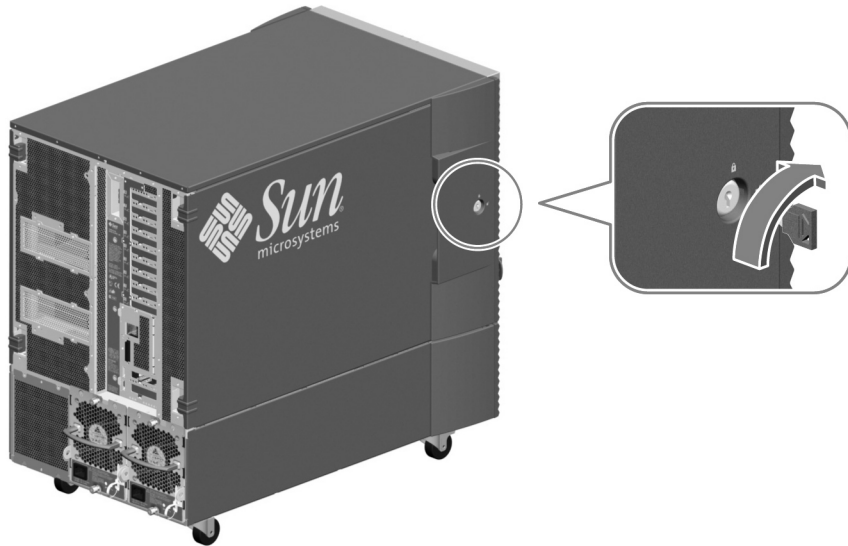

2. Swing the side door open.

3. To remove the door completely, open the door 90 degrees and lift it up until its mounting pins clear the hinge brackets on the rear panel.

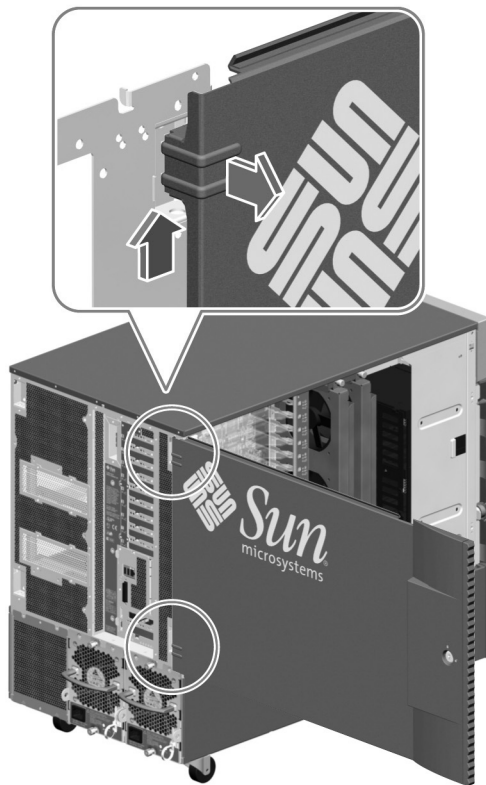

What Next

You are now ready to install, remove, or replace components inside the system chassis.

How to Avoid Electrostatic Discharge

Use the following procedure to prevent static damage whenever you are accessing any of the internal components of the system.

Note – Internal access to the Sun Fire 880 system is restricted to qualified service personnel only. Installation procedures for internal components are covered in the *Sun Fire 880 Server Service Manual*, which is included on the Sun Fire 880 Documentation CD.

Before You Begin

Complete this task if you are working with a component that is not hot-pluggable:

- “How to Power Off the System” on page 53

You must have the following items:

- Antistatic wrist or foot strap
- Antistatic mat (or the equivalent)

What to Do



Caution – Printed circuit boards and hard disk drives contain electronic components that are extremely sensitive to static electricity. Ordinary amounts of static from your clothes or the work environment can destroy components. Do not touch the components themselves or any metal parts without taking proper antistatic precautions.

1. **Make sure that at least one AC power cord remains connected between a power supply and an AC power outlet.**

Note – The AC power cord provides a discharge path for static electricity, so you generally want to leave it plugged in during installation and repair procedures. The only time you should unplug the power cords is when you service the power distribution board or Remote System Control (RSC) card. In each case, make sure that all power cords are disconnected.

2. Use an antistatic mat or similar surface.

When performing any option installation or service procedure, place static-sensitive parts, such as boards, cards, and disk drives, on an antistatic surface. The following items can be used as an antistatic surface:

- The bag used to wrap a Sun replacement part
- The shipping container used to package a Sun replacement part
- Sun electrostatic discharge (ESD) mat, Sun part number 250-1088 (available through your Sun sales representatives)
- Disposable ESD mat, shipped with replacement parts or options

3. Use an antistatic wrist strap.

Attach one end of the strap to the system chassis sheet metal, and attach the other end to your wrist. Refer to the instructions that come with the strap.

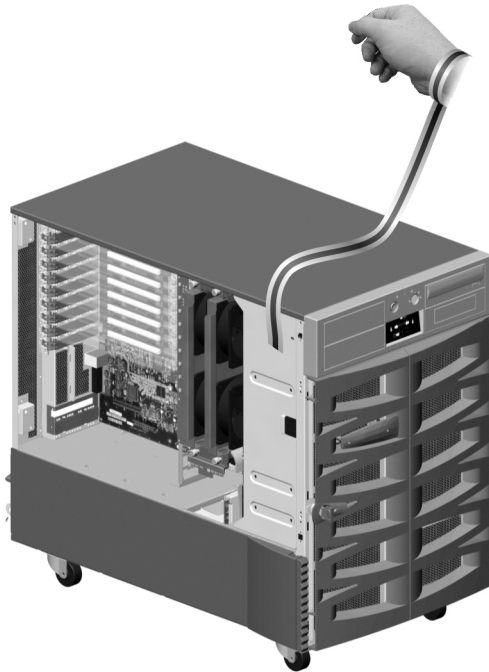

4. Detach both ends of the strap after you complete the installation or service procedure.

How to Install a Disk Drive

Before You Begin

The system's disk drive hot-plug feature lets you install a disk drive without shutting down the operating system or turning off the system power. For more information, see:

- "About Internal Disk Drives" on page 97
- "About Hot-Pluggable and Hot-Swappable Components" on page 144

Note – You can only perform disk hot-plug operations while the operating system is running. Disk hot-plug operations are not supported when the system ok prompt is displayed.

You need a system console in order to perform disk hot-plug operations; see:

- "About Setting Up a Console" on page 45

You must follow antistatic precautions when handling a disk drive; see:

- "How to Avoid Electrostatic Discharge" on page 31

What to Do

- 1. If you are performing a hot-plug operation, prepare the system to receive the new disk drive.**

The hot-plug installation procedure involves software commands for preparing the system prior to installing the disk drive. See "About Hot-Pluggable and Hot-Swappable Components" on page 144.

- 2. If you are not performing a hot-plug operation, halt the operating system and power off the system.**

See "How to Power Off the System" on page 53.

- 3. Unlock and open the front door, if it is not open already.**
- 4. Attach the antistatic wrist strap to a metal surface inside the system chassis.**
- 5. Release the drive handle on the disk drive to be installed.**

Use your thumb or forefinger to pinch the drive latch upward to open it.

6. Align the disk drive with its drive bay.

Orient the drive so that the drive handle's hinge faces the bottom of the drive bay.

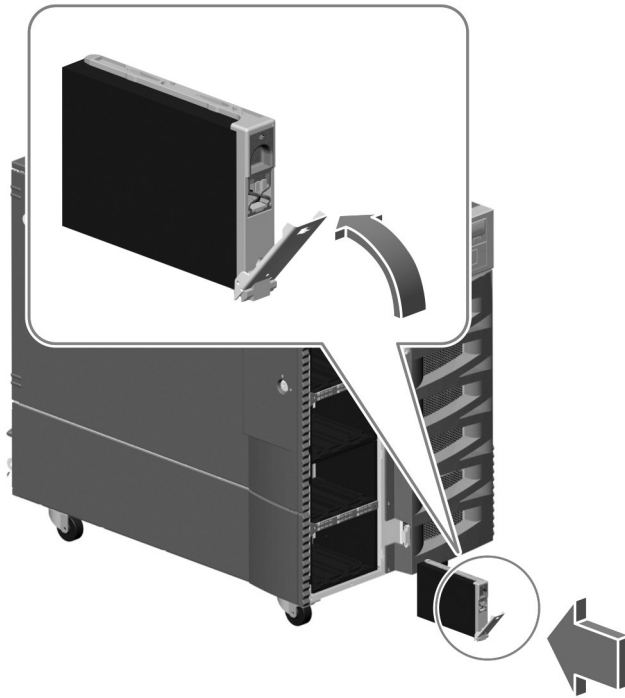

7. Holding the drive by its handle, fit the drive into the guide rails at the top and bottom of the drive bay.

8. Slide the drive into the bay until it barely contacts the backplane.

9. Press carefully on the center of the drive and watch as the handle begins to close.

The drive handle begins to close as the drive engages its backplane connector.

10. Press the handle toward the drive until the latch closes, securing the drive in place.

11. Close the front door and lock it, if necessary.

12. If you are performing a hot-plug installation, complete the software part of the installation procedure.

See "About Hot-Pluggable and Hot-Swappable Components" on page 144.

What Next

If you installed a disk drive as part of the initial system installation procedure, resume the procedure at Step 4. See:

- “How to Install the Sun Fire 880 Server” on page 25

If the operating system has been installed already, and you added the disk drive while the system was powered off, you need to perform a reconfiguration boot so that your system is able to recognize the new disk drive(s). See:

- “How to Initiate a Reconfiguration Boot” on page 55

How to Remove a Disk Drive

Before You Begin

The system's disk drive hot-plug feature lets you remove a disk drive without shutting down the operating system or turning off the system power. For more information, see:

- "About Internal Disk Drives" on page 97
- "About Hot-Pluggable and Hot-Swappable Components" on page 144

Note – You can only perform disk hot-plug operations while the operating system is running. Disk hot-plug operations are not supported when the system ok prompt is displayed.

You need a system console in order to perform disk hot-plug operations; see:

- "About Setting Up a Console" on page 45

You must follow antistatic precautions when handling a disk drive; see:

- "How to Avoid Electrostatic Discharge" on page 31

What to Do

1. Unlock and open the front door.

2. Identify the disk drive to be removed.

For information about disk status LEDs, see "About Disk Drive LEDs" on page 166.

3. If you are performing a hot-plug operation, prepare the system for disk removal.

The hot-plug removal procedure involves software commands for preparing the system prior to removing the disk drive. See "About Hot-Pluggable and Hot-Swappable Components" on page 144.

4. If you are not performing a hot-plug operation, halt the operating system and power off the system.

See "How to Power Off the System" on page 53.

5. Attach an antistatic wrist strap to a metal surface inside the system chassis.

6. Using your thumb or forefinger, push the drive latch upward to release the drive handle.

Swing the handle away from the drive until you feel the drive connector disengage from the backplane. Do not use excessive force.

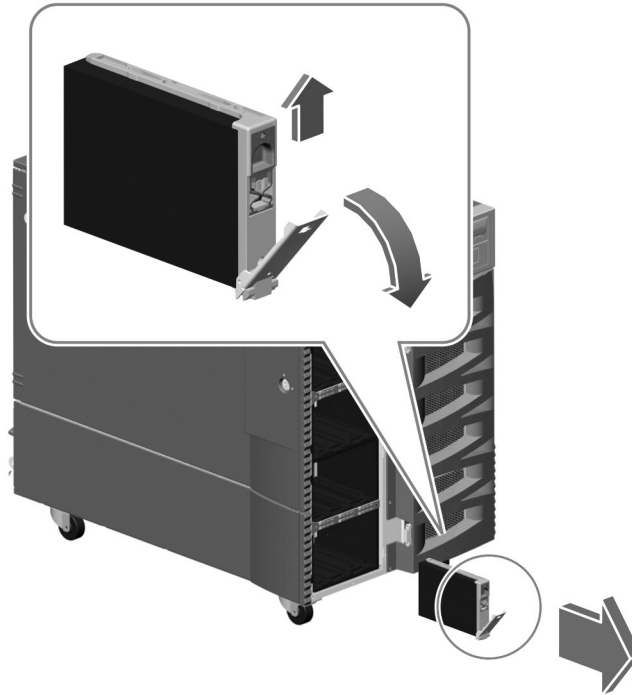

Caution – If you are hot-plugging the disk drive, after disconnecting it from the backplane, allow 30 seconds or so for the drive to spin down completely before removing it from the system.

7. **Holding the drive by the handle, carefully slide it out of the drive bay.**
Place the drive on an antistatic mat.
8. **If you are performing a hot-plug operation, complete the software part of the removal procedure.**
See “About Hot-Pluggable and Hot-Swappable Components” on page 144.

What Next

If you need to install a replacement drive, complete the following task, starting with Step 5:

- “How to Install a Disk Drive” on page 33

If you removed the disk drive while the system was powered off, and you are not replacing the drive right away, you need to perform a reconfiguration boot. A reconfiguration boot is required in order for the operating system to recognize the configuration change. See:

- “How to Initiate a Reconfiguration Boot” on page 55

How to Install a Power Supply

Before You Begin

If you are installing a redundant power supply, it is not necessary to shut down and power off the system. For more information, see:

- “About Power Supplies” on page 73
- “About Hot-Pluggable and Hot-Swappable Components” on page 144

Note – After removing a power supply during a hot-plug operation, wait for an acknowledgement message on the system console before installing a new supply; otherwise, the environmental monitoring software will not recognize the new device and false error conditions will result.

What to Do

1. **If you are upgrading your system with an additional power supply, remove the filler panel covering the empty power supply bay.**
Remove the two Phillips screws that secure the panel to the chassis and slide the panel out of the bay.
2. **Slide the new power supply into the empty bay until the power supply connectors start to engage the connectors on the power distribution board.**
3. **Push firmly on the power supply handle to engage the power supply connectors.**



Caution – If you are hot-plugging a redundant supply, take care to avoid jarring or shocking the system. Also, do not engage and disengage the supply in rapid succession. Rapid seating and unseating of a power supply will result in false error conditions.

4. Tighten the two captive screws that secure the power supply to the chassis.

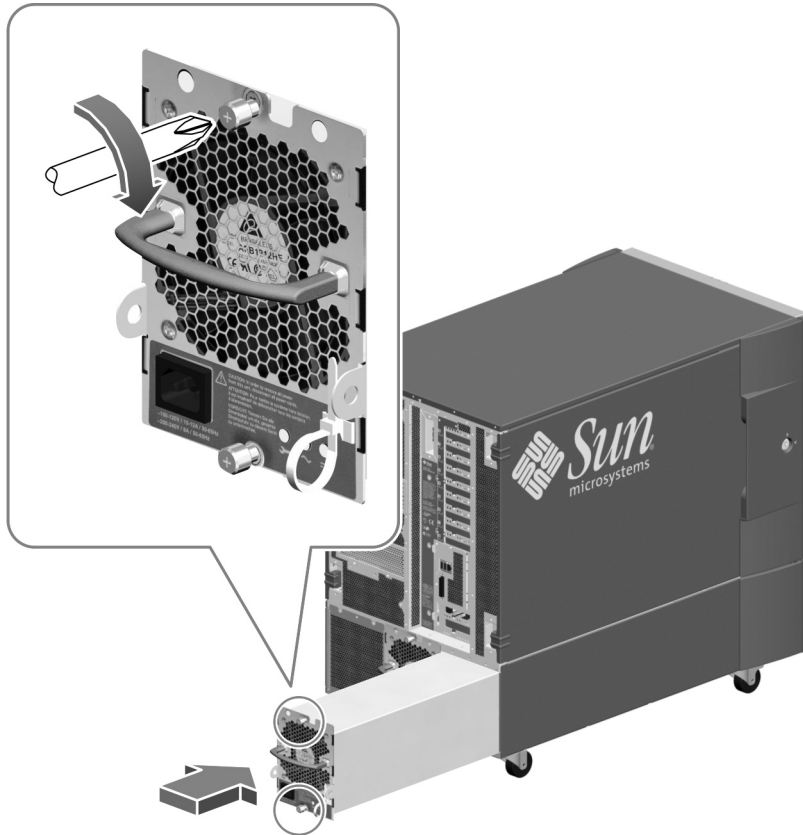

5. Connect the AC power cord to both the power supply and a dedicated AC power outlet.

Insert the female end of the power cord through the strain-relief tie-wrap loop located to the right of the supply. Tighten the tie-wrap to secure the connection.

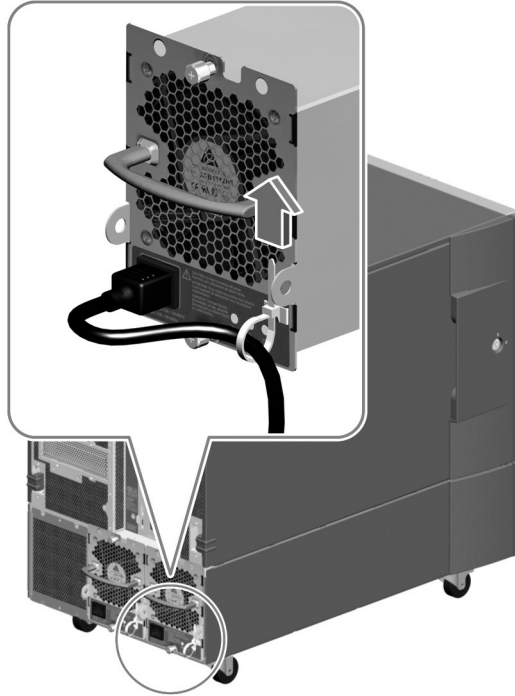

What Next

If you installed a power supply as part of the initial system installation procedure, resume the procedure at Step 4. See:

- “How to Install the Sun Fire 880 Server” on page 25

If the operating system has been installed already, and you added a power supply while the system was powered off, you need to perform a reconfiguration boot. A reconfiguration boot is required in order for the environmental monitoring software to recognize the new power supply. See:

- “How to Initiate a Reconfiguration Boot” on page 55

You can verify correct operation of the power supply by checking the fan and the LED indicators on the back of the supply. The fan should start spinning and the two green status LEDs should light within three seconds of completing a hot-plug installation (or after restoring power to the system).

For more information, see:

- “About Power Supply LEDs” on page 163

How to Remove a Power Supply



Caution – Power supply bays 0 and 1 must always contain power supplies. If a power supply in either bay fails and the system can continue to operate, you must leave the failed power supply in its bay until you are able to install a functioning replacement power supply. A failed power supply in bay 0 or 1 still acts as an air baffle, channeling airflow to cool the bottom row of disk drives in the disk cage. The failed power supply should be replaced as soon as possible to regain N+1 power redundancy.

Before You Begin

It is not necessary to power off the system if you are removing a redundant power supply. For more information see:

- “About Power Supplies” on page 73
- “About Hot-Pluggable and Hot-Swappable Components” on page 144

If your system has only two power supplies, complete this task:

- “How to Power Off the System” on page 53

What to Do

1. Identify the power supply to be removed.

To locate a faulty supply, check the status LED on the back of each supply. See “About Power Supply LEDs” on page 163.

2. Release the AC power cord from the releasable tie wrap at the rear of the supply.

Press the tab on the head of the tie wrap to release it.

3. Unplug both ends of the AC power cord.

4. Loosen the two captive Phillips screws securing the power supply to the system rear panel.

5. Grasp the handle and carefully pull the power supply out of its bay.

Place one hand beneath the supply to support it as you slide it out of the bay.

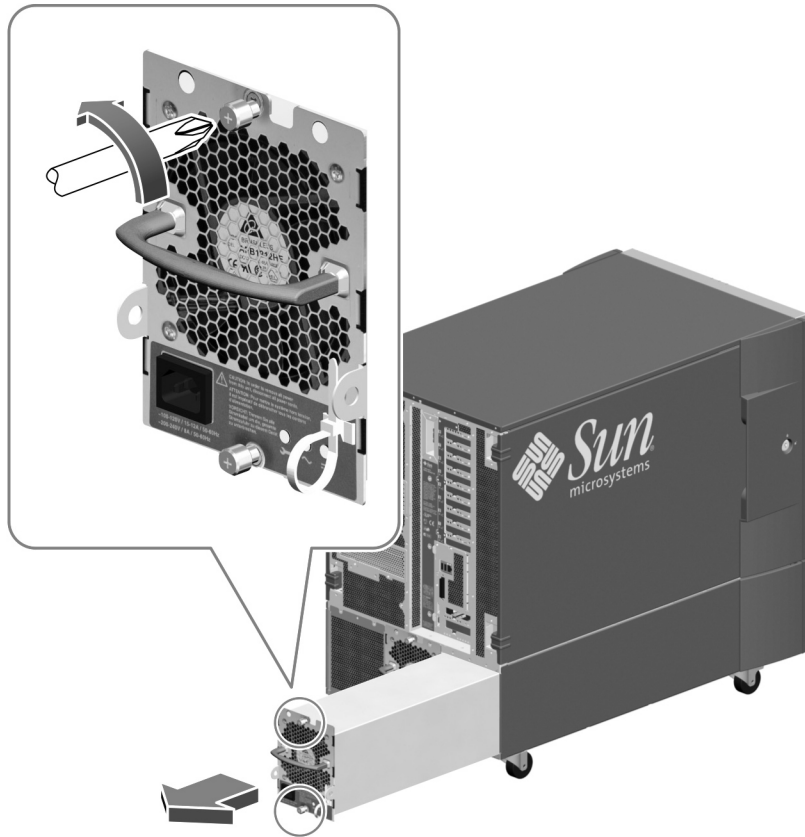

Note – When hot-swapping a power supply, do not disengage and reengage the supply in rapid succession. Rapid seating and unseating of a power supply will result in false error conditions. After removing a supply, wait for an acknowledgement message on the system console before installing a new supply; otherwise, the environmental monitoring software will not recognize the new device and false error conditions will result.

6. If you removed a power supply from the left-hand bay and you are not replacing it immediately, install a power supply filler panel into the empty bay.

Insert the power supply filler panel into the bay and tighten the two Phillips screws that secure the filler panel to the back of the system.

What Next

To replace a power supply, complete this task:

- “How to Install a Power Supply” on page 39

About Setting Up a Console

To install your server or to diagnose problems, you need some way to enter system commands and view system output. There are four ways to do this.

1. Attach an ACSII character terminal to serial port A.

You can attach a simple terminal to serial port A. For instructions, see “How to Attach an Alphanumeric Terminal” on page 46.

2. Establish a `tip` connection from another Sun system.

For information about establishing a `tip` connection, see the *OpenBoot 4.x Command Reference Manual*. An online version of the manual is included with the *OpenBoot Collection AnswerBook* that ships with Solaris software.

3. Install a local graphics console on your server.

The server is often shipped without a mouse, keyboard, monitor, or frame buffer for the display of graphics. To install a local graphics console on a server, you must install a graphics frame buffer card in a PCI slot, and attach a monitor, mouse, and keyboard to the appropriate rear panel ports. For detailed instructions, see “How to Configure a Local Graphics Console” on page 48.

4. Set up a Remote System Control (RSC) console.

RSC is a remote server management tool that lets you monitor and control your server over modem lines or over a network. RSC provides convenient remote system administration for geographically distributed or physically inaccessible systems. For additional details, see “About the Remote System Control Card” on page 71 and “About Sun Remote System Control Software” on page 150.

Note – You cannot use an RSC console to perform the initial installation of the Solaris operating environment. The operating environment must be installed prior to setting up an RSC console. Once you install the operating environment and the RSC software, you can configure the system to use RSC as the system console. For detailed instructions, see “How to Redirect the System Console to RSC” on page 58.

How to Attach an Alphanumeric Terminal

Before You Begin

If your server is configured without a local graphics console, you need to attach an alphanumeric (ASCII) terminal to the server in order to install the operating environment and to run diagnostic tests. Alternatively, you can install a local graphics console, create a `tip` connection from another Sun system, or set up an RSC console. For more information, see “About Setting Up a Console” on page 45.

Note – You cannot use an RSC console to perform the initial installation of the Solaris operating environment. The operating environment must be installed prior to setting up an RSC console.

What to Do

1. Connect a DB-25 null modem serial cable or a DB-25 serial cable and null modem adapter to the terminal’s serial port.

2. Connect the opposite end of the cable to the system's serial port connector or to serial port A on the serial splitter cable.

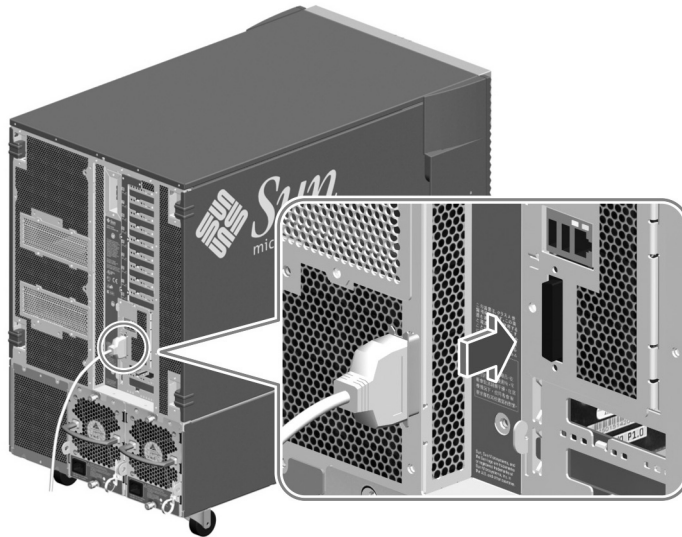

3. Connect the terminal's power cable to an AC outlet.
4. Set the terminal to receive:
 - At 9600 baud
 - An 8-bit signal with no parity and 1 stop bit

See the documentation accompanying your terminal for more information.

What Next

You can now issue system commands and view system messages. Continue with your installation or diagnostic procedure as needed.

How to Configure a Local Graphics Console

Before You Begin

If your server is configured without a local alphanumeric (ASCII) terminal, you need to install a local graphics console in order to install the operating environment and to run diagnostic tests. Alternatively, you can attach an alphanumeric terminal, create a `tip` connection from another Sun system, or set up an RSC console. For more information, see “About Setting Up a Console” on page 45.

Note – You cannot use an RSC console to perform the initial installation of the Solaris operating environment. The operating environment must be installed prior to setting up an RSC console.

To install a local graphics console, you must have:

- A supported PCI-based graphics card
- A monitor (CRT) with appropriate resolution
- A Sun Type 6 USB keyboard
- A Sun Type 6 USB mouse and mouse pad

What to Do

1. Install the graphics card into a vacant PCI slot.

For information about PCI buses and slots, see “About PCI Cards and Buses” on page 68.

Note – PCI cards must be installed only by qualified service personnel. Installation procedures for PCI cards are covered in the *Sun Fire 880 Server Service Manual*, which is included on the Sun Fire 880 Documentation CD.

2. Attach the monitor video cable to the graphic card's video port.
Tighten the thumbscrews to secure the connection.

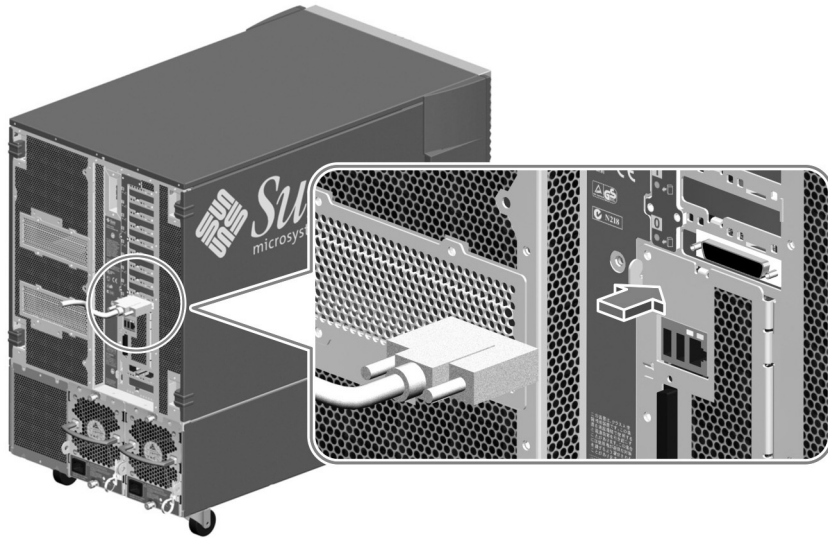

3. Connect the monitor's power cord to an appropriate AC power outlet.
4. Attach the keyboard cable to one of the system's USB ports.

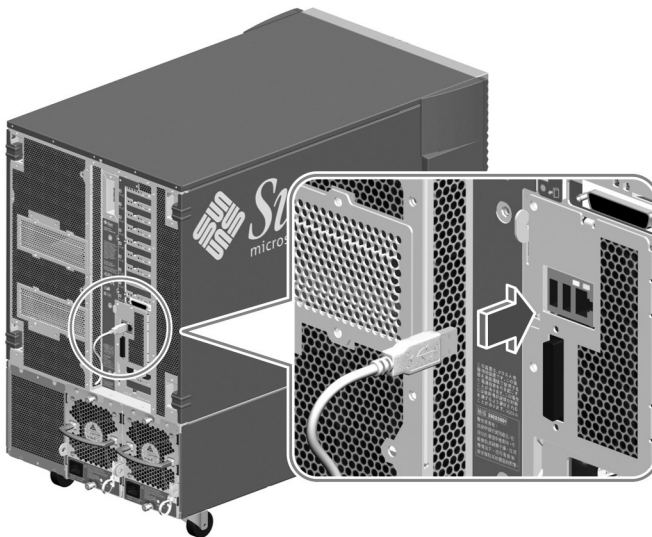

5. **Attach the mouse cable to the system's remaining USB port, or to a USB port on the keyboard, if applicable.**

What Next

You can now issue system commands and view system messages. Continue with your installation or diagnostic procedure as needed.

How to Power On the System

Before You Begin

Do not use this power-on procedure if the operating system is already installed and you have just added a new internal option or external storage device. To power on the system after adding one of these options, see:

- “How to Initiate a Reconfiguration Boot” on page 55

What to Do



Caution – Before you power on the system, make sure that the front and side doors and all plastic outer panels are properly installed.

1. Turn on power to any peripherals and external storage devices.
2. Turn on power to the alphanumeric terminal or local graphics console, if present.
3. Insert the system key into the front panel keyswitch and turn it to the Normal or Diagnostics position.

See “About the Status and Control Panel” on page 10 for more information.

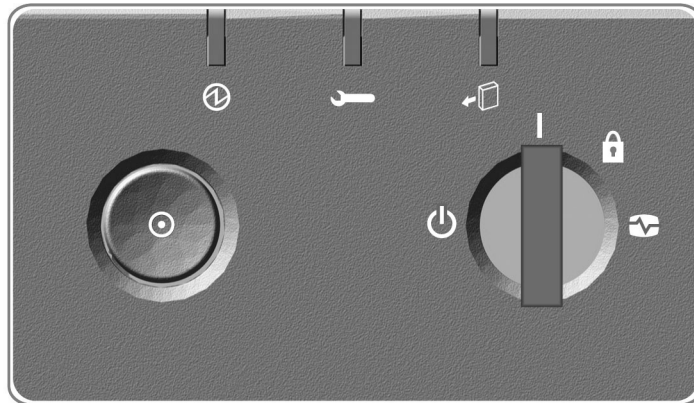

4. Press the Power button to the left of the keyswitch to power on the system.

Note – The system may take anywhere from 30 seconds to two minutes before video is displayed on the system monitor or the `ok` prompt appears on an attached terminal. This time depends on the system configuration (number of CPUs, memory modules, PCI cards) and the level of power-on self-test (POST) and OpenBoot Diagnostics being performed.

5. Turn the keyswitch to the Locked position.

This prevents anyone from accidentally powering off the system.

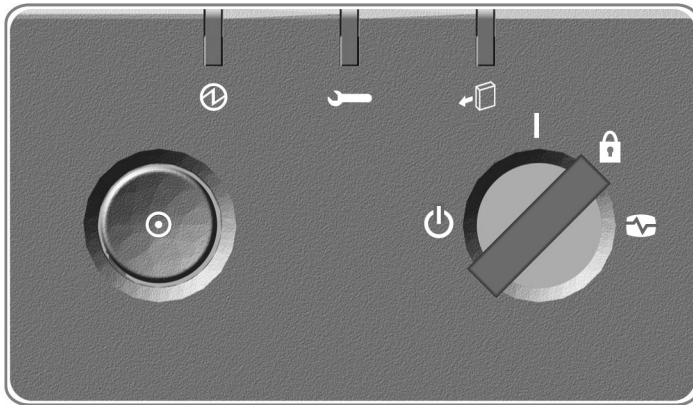

6. Remove the key from the keyswitch and keep it in a secure place.

What Next

The system's front panel LED indicators provide power-on status information. For more information about the system LEDs, see "About the Status and Control Panel" on page 10.

If your system encounters a problem during system start up, and the keyswitch is in the Normal position, try restarting the system in Diagnostics mode to determine the source of the problem. Turn the front panel keyswitch to the Diagnostics position and power cycle the system. See:

- "How to Power Off the System" on page 53
- "How to Power On the System" on page 51

For information about system troubleshooting and diagnostics, see the *Sun Fire 880 Server Service Manual*.

How to Power Off the System

What to Do

1. Notify users that the system will be powered down.
2. Back up the system files and data, if necessary.
3. Ensure that the front panel keyswitch is in the Normal or Diagnostics position.

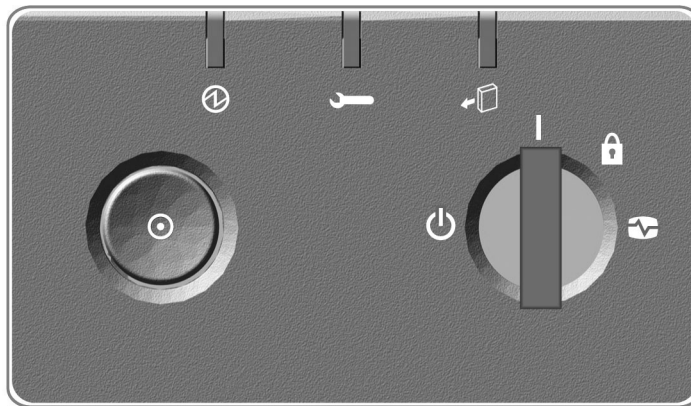

4. Press and release the Power button on the system front panel.
The system begins a graceful software system shutdown.

Note – Pressing and releasing the Power button initiates a graceful software system shutdown. Pressing and holding in the Power button for five seconds causes an immediate hardware shutdown. Whenever possible, you should use the graceful shutdown method. Forcing an immediate hardware shutdown may cause disk drive corruption and loss of data. Use this method only as a last resort.

5. Wait for the front panel Power/OK LED to turn off.

6. Turn the keyswitch fully counterclockwise to the Forced Off position.

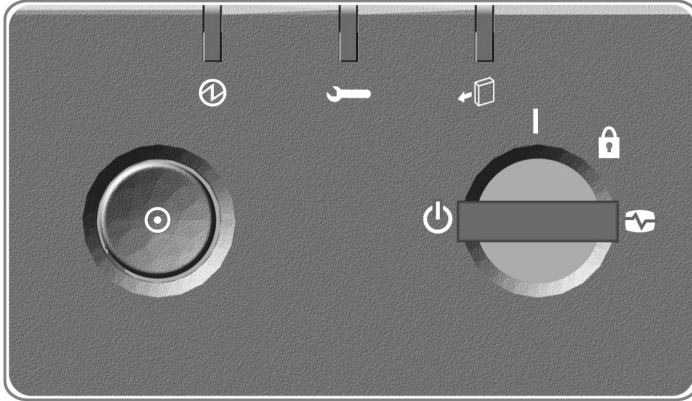

Caution – Be sure to turn the keyswitch to the Forced Off position before handling any internal components. Otherwise, it is possible for an RSC user to restart the system remotely while you are working inside it. The Forced Off position is the only keyswitch position that prevents an RSC user from restarting the system.

7. Remove the key from the keyswitch and keep it in a secure place.

How to Initiate a Reconfiguration Boot

After installing any new internal option or external storage device, you must perform a reconfiguration boot so that the operating system is able to recognize the newly installed device(s). In addition, if you remove any device and do not install a replacement device prior to rebooting the system, you must perform a reconfiguration boot in order for the operating system to recognize the configuration change. This requirement also applies to any component that is connected to the system's I²C bus, including memory modules, CPU/Memory boards, and power supplies.

This requirement *does not* apply to any component that is:

- Installed or removed as part of a hot-plug operation
- Installed or removed before the operating system is installed or
- Installed as an identical replacement for a component that is already recognized by the operating system

Before You Begin



Caution – Before you power on the system, make sure that the front and side doors and all plastic outer panels are properly installed.

You need a system console in order to issue software commands; see:

- “About Setting Up a Console” on page 45

What to Do

- 1. Turn on power to any peripherals and external storage devices.**
Read the documentation supplied with the device for specific instructions.
- 2. Turn on power to the ASCII terminal or local graphics console, if present.**
- 3. Insert the system key into the front panel keyswitch and turn it to the Diagnostics position.**

Use the Diagnostics position to run POST and OpenBoot Diagnostics tests to verify that the system functions correctly with the new part(s) you just installed. See “About the Status and Control Panel” on page 10 for information about keyswitch settings.

4. Press the Power button to the left of the keyswitch to power on the system.

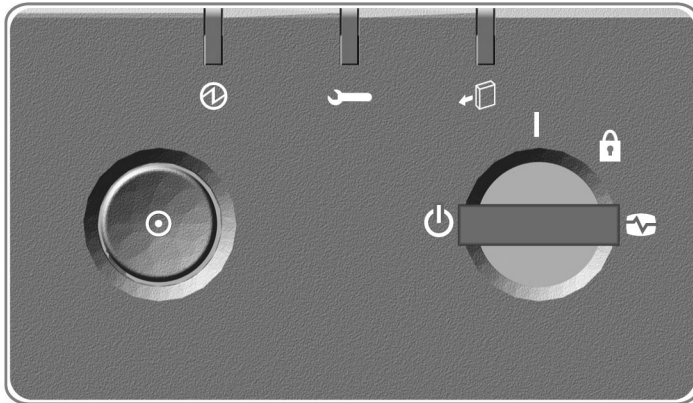

5. When the diagnostic tests are completed, and the system banner is displayed on the system console, immediately abort the boot process to access the system `ok` prompt.

The system banner contains the Ethernet address and host ID. To abort the boot process, use one of the following methods:

- Hold down the Stop key and press A on a Sun keyboard.
- Press the Break key on the terminal keyboard.
- Type `~#` in a `tip` window.
- Issue the RSC `break` command

Note – The system may take anywhere from 30 seconds to two minutes before the system banner appears. This time depends on the system configuration (number of CPUs, memory modules, PCI cards) and the level of power-on self-test (POST) and OpenBoot Diagnostics being performed.

6. At the `ok` prompt, type:

```
ok env-on
Environmental monitor is ON
ok boot -r
```

The `env-on` command re-enables the OpenBoot environmental monitor, which may have been disabled as a result of the abort key sequence. The `boot -r` command rebuilds the device tree for the system, incorporating any newly installed options so that the operating system will recognize them.

7. Turn the keyswitch to the Locked position, remove the key, and keep it in a secure place.

This prevents anyone from accidentally powering off the system.

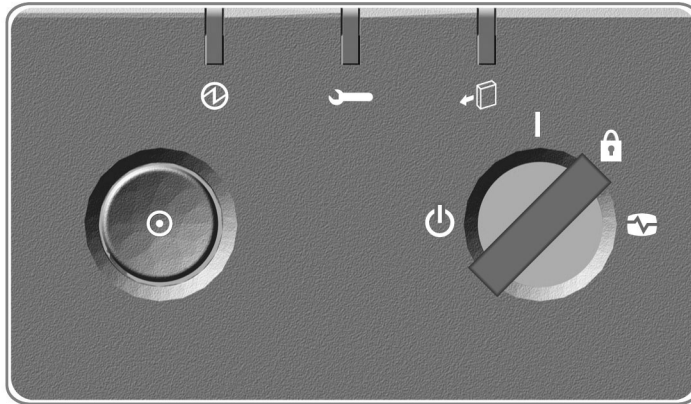

What Next

The system's front panel LED indicators provide power-on status information. For more information about the system LEDs, see "About the Status and Control Panel" on page 10.

If your system encounters a problem during system start up, and the keyswitch is in the Normal position, try restarting the system in Diagnostics mode to determine the source of the problem. Turn the front panel keyswitch to the Diagnostics position and power cycle the system. See:

- "How to Power Off the System" on page 53
- "How to Initiate a Reconfiguration Boot" on page 55

For information about system troubleshooting and diagnostics, see the *Sun Fire 880 Server Service Manual*.

How to Redirect the System Console to RSC

Perform this procedure if, after installing the Solaris operating environment and the RSC software, you want to configure the system to use RSC as the system console. For more information about RSC, see “About the Remote System Control Card” on page 71 and “About Sun Remote System Control Software” on page 150.

Before You Begin

This procedure assumes that you are familiar with the OpenBoot firmware and that you know how to enter the OpenBoot environment. For more information about the OpenBoot firmware, see the *OpenBoot 4.x Command Reference Manual*. An online version of the manual is included with the *OpenBoot Collection AnswerBook* that ships with Solaris software.

What to Do

1. Type the following commands at the system `ok` prompt:

```
ok diag-console rsc
ok setenv input-device rsc-console
ok setenv output-device rsc-console
```

2. To cause the changes to take effect, power cycle the system, or type:

```
ok reset-all
```

The system permanently stores the parameter changes and boots automatically if the OpenBoot variable `auto-boot?` is set to `true` (its default value).

Note – In the unlikely event that the RSC card fails while the system console is directed to RSC, the system console will be unavailable. To recover from this situation, press the system Power button to initiate a graceful software shutdown. Then use the OpenBoot emergency procedure for resetting NVRAM configuration variables to their default values. See “About OpenBoot Emergency Procedures” on page 138. This will *temporarily* redirect the system console to the local console device, but only until the next system reset. If you are not installing a replacement RSC card right away, you must *permanently* restore the local system console until a replacement card is available. See “How to Restore the Local System Console” on page 60.

Note – All internal options (except disk drives and power supplies) must be installed only by qualified service personnel. Installation procedures for these components are covered in the *Sun Fire 880 Server Service Manual*, which is included on the Sun Fire 880 Documentation CD.

What Next

For instructions on how to use RSC, see the *Sun Remote System Control (RSC) User's Guide* provided with the RSC software.

How to Restore the Local System Console

Perform this procedure if your system is configured to use RSC as the system console and you need to redirect the system console to a local graphics console, alphanumeric terminal, or an established `tip` connection. For more information about RSC, see “About the Remote System Control Card” on page 71 and “About Sun Remote System Control Software” on page 150.

Before You Begin

This procedure assumes that you are familiar with the OpenBoot firmware and that you know how to enter the OpenBoot environment. For more information about the OpenBoot firmware, see the *OpenBoot 4.x Command Reference Manual*. An online version of the manual is included with the *OpenBoot Collection AnswerBook* that ships with Solaris software.

What to Do

1. Type the following commands at the system `ok` prompt:

```
ok diag-console ttya
ok setenv input-device keyboard
ok setenv output-device screen
```

2. To cause the changes to take effect, power cycle the system, or type:

```
ok reset-all
```

The system permanently stores the parameter changes and boots automatically if the OpenBoot variable `auto-boot?` is set to `true` (its default value).

What Next

You can now issue commands and view system messages on the local console.

Hardware Configuration

This chapter provides hardware configuration information for the Sun Fire 880 server. The following topics are covered in this chapter:

- “About CPU/Memory Boards” on page 62
- “About Memory Modules” on page 64
- “About PCI Cards and Buses” on page 68
- “About the Remote System Control Card” on page 71
- “About Power Supplies” on page 73
- “About Fan Trays” on page 75
- “About Removable Media Devices” on page 78
- “About the Serial Ports” on page 79
- “About the USB Ports” on page 80
- “About Hardware Jumpers” on page 81
- “About Serial Port Jumpers” on page 82
- “About Flash PROM Jumpers” on page 83

Note – For configuration information about the internal mass storage subsystem, see “Mass Storage Subsystem Configuration” on page 89. For configuration information about network interfaces, see “Configuring Network Interfaces” on page 103.

About CPU/Memory Boards

The system motherboard provides slots for up to four CPU/Memory boards. Each CPU/Memory board incorporates two UltraSPARC III microprocessors, with 8 Mbytes of static random access memory (SRAM) external cache memory per processor, and slots for up to 16 memory modules. The external cache memory cannot be upgraded; it is fixed at 8 Mbytes, which is the maximum amount that the UltraSPARC III architecture supports.

The following illustration shows the four CPU/Memory board slots on the system motherboard. The slots are labeled A through D from bottom to top. The CPUs in the system are numbered from 0 to 7, depending on the slot where each CPU resides. For example, a CPU/Memory board installed in slot D always contains CPUs 5 and 7, even if there are no other CPU/Memory boards installed in the system.

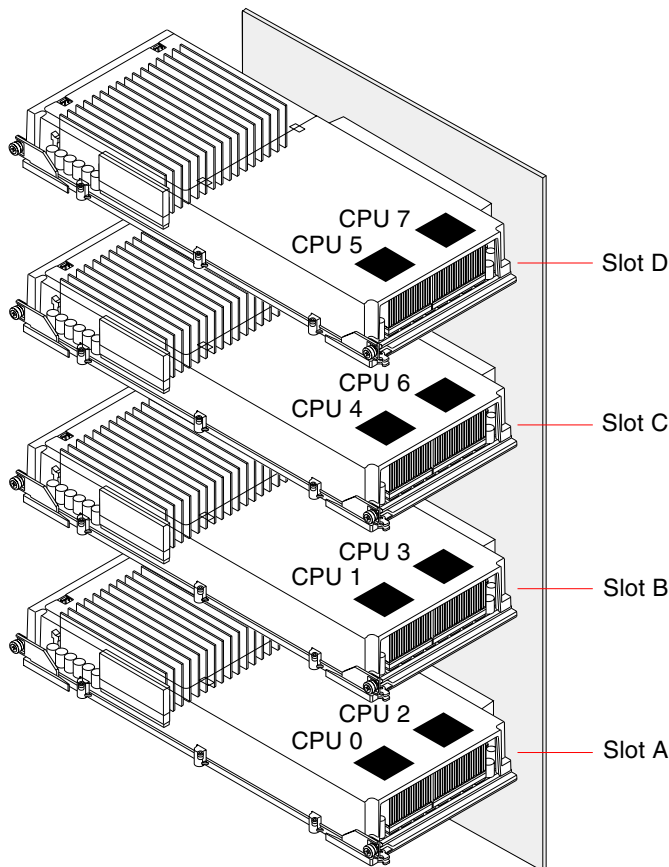

The UltraSPARC III microprocessor is a high-performance, highly integrated superscalar processor implementing the SPARC V9 64-bit Reduced Instruction Set Computing (RISC) architecture. The UltraSPARC III processor supports both 2D and 3D graphics, as well as image processing, video compression and decompression, and video effects through the sophisticated Visual Instruction Set (VIS) extension. VIS provides high levels of multimedia performance, including real-time video compression and decompression and two streams of MPEG-2 decompression at full broadcast quality with no additional hardware support.

The Sun Fire 880 server employs a shared-memory multiprocessor architecture with all processors sharing the same physical address space. The system processors, main memory, and I/O subsystem communicate via a high-speed system interconnect bus, operating at a clock rate of 150 MHz. In a system configured with multiple CPU/Memory boards, all main memory is accessible from any processor over the system bus. The main memory is shared logically by all processors and I/O devices in the system.

For information about memory modules and memory configuration guidelines, see “About Memory Modules” on page 64.

Note – After installing a CPU/Memory board, you must perform a reconfiguration boot in order for the operating system to recognize the new device. See “How to Initiate a Reconfiguration Boot” on page 55.

Note – All internal options (except disk drives and power supplies) must be installed only by qualified service personnel. For information about installing or removing CPU/Memory boards, see the *Sun Fire 880 Server Service Manual*, which is included on the Sun Fire 880 Documentation CD.



Caution – Either a CPU/Memory board or an air baffle must be installed in each CPU/Memory slot at all times. After removing a CPU/Memory board, you must install a replacement board or an air baffle immediately to avoid an automatic thermal shutdown. For more information, see “Environmental Monitoring and Control” on page 16.

About Memory Modules

The Sun Fire 880 server uses 3.3-volt, high-capacity next generation dual inline memory modules (DIMMs). The DIMMs are built with synchronous dynamic random access memory (SDRAM) chips that operate at a 75-MHz clock frequency. The system supports DIMMs with 128-, 256-, and 512-Mbyte capacities, with future support for higher capacities as they become available.

Each CPU/Memory board contains slots for 16 DIMMs. Total system memory ranges from a minimum of 1 Gbyte (one CPU/Memory board with eight 128-Mbyte DIMMs) to a maximum of 32 Gbytes (four boards fully populated with 512-Mbyte DIMMs).

Within each CPU/Memory board, the 16 DIMM slots are organized into groups of four. The system reads from, or writes to, all four DIMMs in a group simultaneously. DIMMs, therefore, must be added in sets of four. The figure below shows the DIMM slots and DIMM groups on a Sun Fire 880 CPU/Memory board. Every fourth slot belongs to the same DIMM group. The four groups are designated A0, A1, B0, and B1.

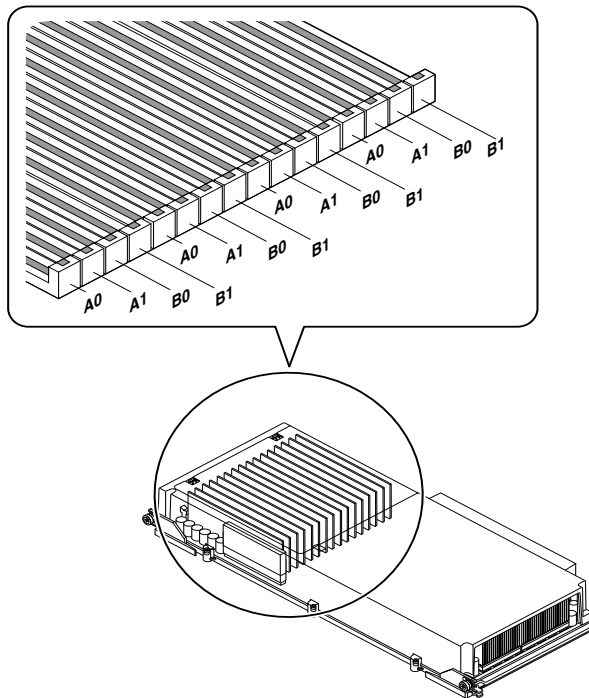

You must physically remove a CPU/Memory board from the system before you can install or remove DIMMs. The DIMMs must be added four-at-a-time within the same DIMM group, and each group used must have four identical DIMMs installed—that is, all four DIMMs in the group must be from the same manufacturing vendor and must have the same capacity (for example, four 128-Mbyte DIMMs, four 256-Mbyte DIMMs, or four 512-Mbyte DIMMs).

Note – Each CPU/Memory board must be populated with a minimum of eight DIMMs, installed in groups A0 and B0.

Memory Interleaving

You can maximize the system's memory bandwidth by taking advantage of its memory interleaving capabilities. Sun Fire 880 systems support two-way, four-way, and eight-way memory interleaving. In most cases, higher interleaving factors result in greater system performance. However, actual performance results may vary depending on the system application.

The system's interleaving capabilities are summarized as follows:

- Memory interleaving is limited to memory within the same CPU/Memory board. Memory interleaving between CPU/Memory boards is not supported.
- Eight-way interleaving occurs automatically when all 16 DIMM slots in a CPU/Memory board are filled with identical capacity DIMMs (16 identical DIMMs).
- Four-way interleaving occurs automatically between any two DIMM groups that are configured identically (eight identical capacity DIMMs).
- Two-way interleaving occurs automatically in any DIMM group where the DIMM capacities do not match the capacities used in any other group.

Independent Memory Subsystems

Each Sun Fire 880 CPU/Memory board contains two independent memory subsystems (one per UltraSPARC III CPU). Memory controller logic incorporated into the UltraSPARC III CPU allows each CPU to control its own memory subsystem. One CPU controls DIMM groups A0 and A1, while the other CPU controls DIMM groups B0 and B1.

The Sun Fire 880 system uses a shared memory architecture. During normal system operations, the total system memory is shared by all CPUs in the system. However, in the event of a CPU failure, the two DIMM groups associated with the failed CPU become unavailable to all other CPUs in the system.

The following table shows the association between the CPUs and their corresponding DIMM groups.

CPU Number	CPU/Memory Slot	Associated DIMM Groups
CPU 0	Slot A	A0, A1
CPU 2	Slot A	B0, B1
CPU 1	Slot B	A0, A1
CPU 3	Slot B	B0, B1
CPU 4	Slot C	A0, A1
CPU 6	Slot C	B0, B1
CPU 5	Slot D	A0, A1
CPU 7	Slot D	B0, B1

Configuration Rules

- DIMMs must be added four-at-a-time within the same group of DIMM slots; every fourth slot belongs to the same DIMM group.
- Each group used must have four identical DIMMs installed—that is, all four DIMMs must be from the same manufacturing vendor and must have the same capacity (for example, four 128-Mbyte DIMMs, four 256-Mbyte DIMMs, or four 512-Mbyte DIMMs).
- Each CPU/Memory board must be populated with a minimum of eight DIMMs, installed in groups A0 and B0.

Note – All internal options (except disk drives and power supplies) must be installed only by qualified service personnel. For information about installing or removing DIMMs, see the *Sun Fire 880 Server Service Manual*, which is included on the Sun Fire 880 Documentation CD.



Caution – DIMMs are made of electronic components that are extremely sensitive to static electricity. Static from your clothes or work environment can destroy the modules. Do not remove a DIMM from its antistatic packaging until you are ready to install it on the system board. Handle the modules only by their edges. Do not touch the components or any metal parts. Always wear an antistatic grounding strap when you handle the modules. For more information, see “How to Avoid Electrostatic Discharge” on page 31.

The following table summarizes the guidelines for installing DIMMs in a CPU/Memory board.

Population Sequence	Memory Interleaving Factor
<p>Install first eight DIMMs into groups A0 and B0 (so that every other slot is occupied).</p>	<p>Four-way interleaving if all eight DIMMs are identical; two-way interleaving otherwise</p>
<p>Install next four DIMMs into group A1.</p>	<p>Four-way interleaving between any two groups configured identically; two-way interleaving in any group that does not match the capacities used in any other group</p>
<p>Fill last four available slots (group B1).</p>	<p>Eight-way interleaving if all 16 DIMMs are identical; four-way interleaving between any two groups configured identically; two-way interleaving in any group that does not match the capacities used in any other group</p>

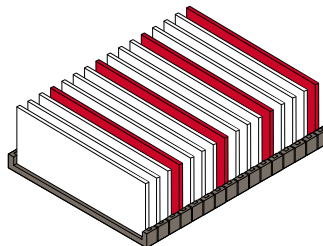
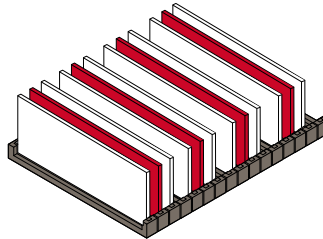
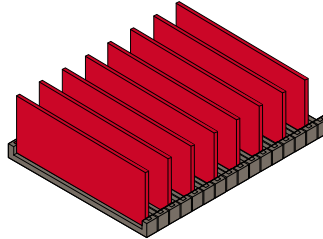

About PCI Cards and Buses

All system communication with storage peripherals and network interface devices is mediated by two Peripheral Component Interconnect (PCI) bridge chips, located on the system's motherboard. Each bridge chip manages communication between the system's main interconnect bus and two PCI buses, giving the system a total of four separate PCI buses. The four PCI buses support up to nine PCI interface cards and four motherboard devices.

The following table describes the PCI bus characteristics and maps each bus to its associated bridge chip, motherboard devices, and PCI slots. All slots comply with PCI Local Bus Specification Revision 2.1.

PCI Bridge	PCI Bus	Clock Rate (MHz)/ Bandwidth (bits)/ Voltage (V)	Motherboard Devices	PCI Slots
0	PCI A	66 MHz/ 64 bits/ 3.3V	Gigabit Ethernet controller FC-AL controller	None
0	PCI B	33 MHz/ 64 bits/ 5V	SCSI controller (interface to the internal DVD drive and optional tape drive)	Slots 0, 1, 2, 3
1	PCI C	33 or 66 MHz/ 64 bits/ 3.3V	None	Slots 7 and 8
1	PCI D	33 MHz/ 64 bits/ 5V	RIO ASIC (Ethernet, USB, and EBus interfaces)	Slots 4, 5, 6

The system's PCI hot-plug feature lets you remove and install PCI cards while the system is running. You can hot-plug any standard PCI card, provided that its Solaris device drivers support PCI hot-plug operations, and the system is running the Solaris 8 7/01 operating environment or a subsequent release that supports Sun Fire 880 PCI hot-plug operations. In addition, the PCI card must comply with the PCI Hot-Plug Specification Revision 1.1.

PCI hot-plug procedures may involve software commands for preparing the system prior to removing a card and for reconfiguring the operating environment after installing a PCI card. For more information about PCI hot-plug procedures, see "About Hot-Pluggable and Hot-Swappable Components" on page 144.

Note – Do not attempt to hot-plug a PCI card until you are certain that its device drivers support PCI hot-plug operations; otherwise, you may cause a system panic. For a list of Sun PCI cards and device drivers that support PCI hot-plug operations, see the *Sun Fire 880 Server Product Notes*.

Status LEDs provide power, fault, and hot-plug status indications for each PCI slot. A contact push button is also provided for each slot, which allows you to initiate the hot-plug procedure at the server. For information about the status indicator LEDs, see “About PCI Slot LEDs” on page 161.

The following figure shows the PCI slots on the I/O board.

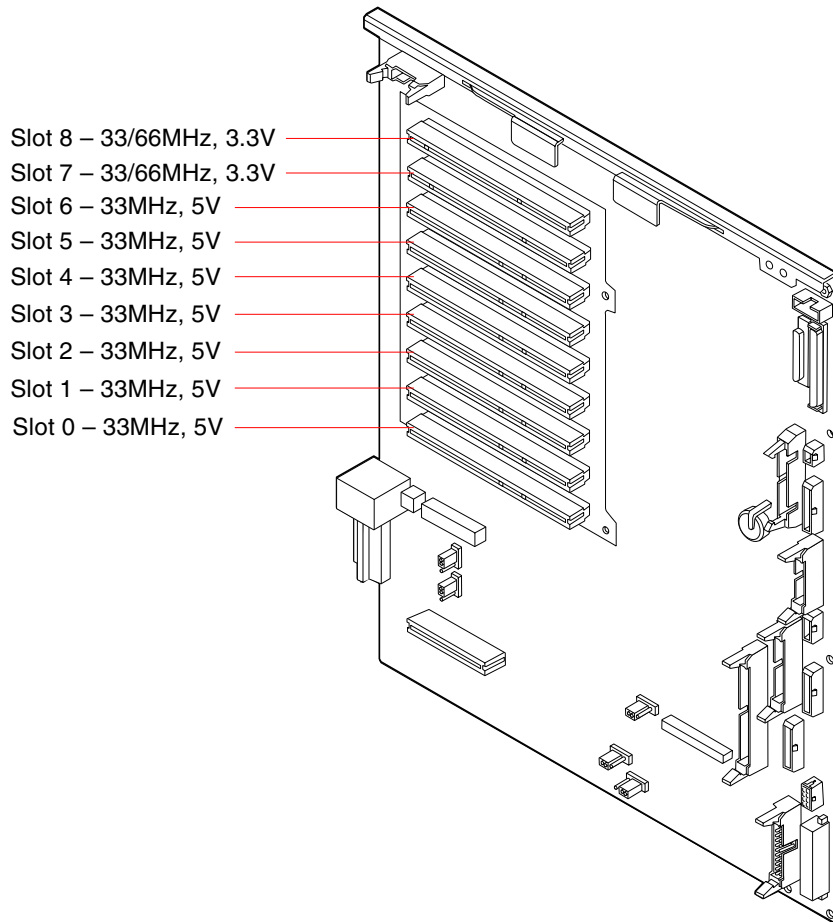

Configuration Rules

- All slots accept short or long PCI cards.
- 5V PCI cards must be installed into 5V slots. 3.3V PCI cards must be installed into 3.3V slots. All slots accept universal (3.3V/5V) PCI cards.
- All slots accept either 32- or 64-bit PCI cards.
- All slots comply with PCI Local Bus Specification Revision 2.1.
- Each slot can supply up to 25 watts of power. The total power used for all nine slots must not exceed 135 watts.
- Compact PCI (cPCI) cards and SBus cards are not supported.
- Slots 7 and 8 can operate at either 33 or 66 MHz; however, both slots always operate at the same speed. When the system is booted, if neither slot contains a 33-MHz PCI card, both slots operate at 66 MHz. If you then add a PCI card to either slot via a hot-plug operation, the card must be a 66-MHz card; a 33-MHz card will fail to operate under these conditions.
- If either slot 7 or 8 contains a 33-MHz PCI card when the system is booted, both slots operate at 33 MHz. In this case, either slot can accept a 33-MHz or 66-MHz card via a hot-plug operation; however, 66-MHz cards will operate at 33 MHz.
- For best performance, install high-throughput cards into slots 7 and 8.
- You can improve overall system availability by installing redundant network or storage interfaces on separate PCI buses and PCI bridges. For additional information, see “About Multipathing Software” on page 148.

Note – All internal options (except disk drives and power supplies) must be installed only by qualified service personnel. For information about installing or removing PCI cards, see the *Sun Fire 880 Server Service Manual*, which is included on the Sun Fire 880 Documentation CD.

About the Remote System Control Card

The Remote System Control (RSC) card enables access, monitoring, and control of the Sun Fire 880 server from a remote location. It is a fully independent processor card with its own resident firmware, power-on self-test (POST) diagnostics, and real-time operating system. The card features modem, serial, and Ethernet interfaces that provide simultaneous access to the Sun Fire 880 server for multiple RSC users. RSC users are provided secure access to the system's Solaris and OpenBoot console functions and have full control over power-on self-test (POST) and OpenBoot Diagnostics.

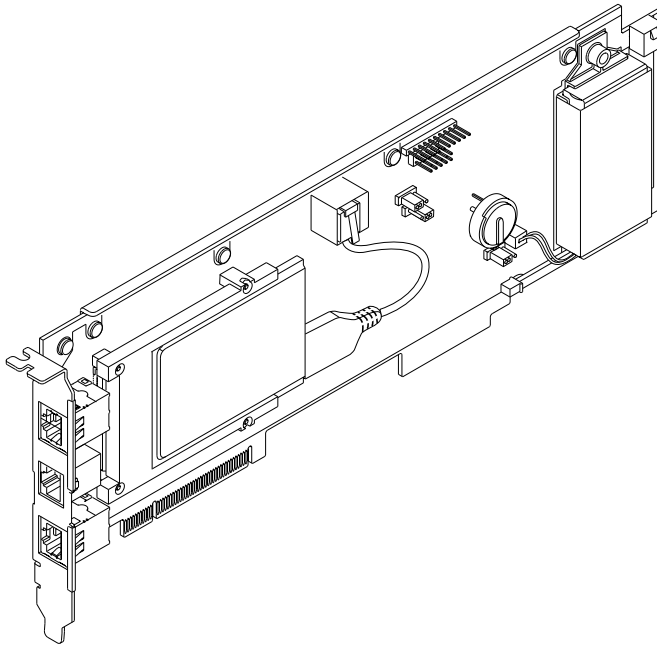

The RSC card runs independently of the host server, and operates off of 5-volt standby power from the system's power supplies. It also includes a back-up battery that enables the card to continue operating for up to 30 minutes in the event of a power failure. The card features on-board devices that interface with the system's environmental monitoring subsystem and can automatically alert administrators to system problems. Together these features allow the RSC card and RSC software to serve as a "lights-out" management tool that continues to function even when the server operating system goes offline, the system is powered off, or a power outage occurs.

The RSC card plugs into a dedicated slot on the system I/O board and provides the following ports through an opening in the system rear panel:

- 10-Mbps Ethernet port via an RJ-45 twisted-pair Ethernet (TPE) connector
- 56-Kbps modem port via an RJ-11 connector
- EIA-232D serial port via an RJ-45 connector

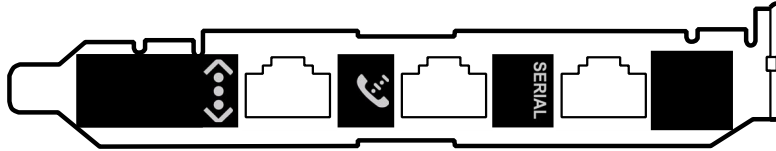

All three RSC connection ports can be used simultaneously. The modem supports regular asynchronous serial protocol, and can also support the Point-to-Point Protocol (PPP). When running PPP, a standard internet TCP/IP 10-Mbps protocol stack is available over the modem interface.

Note – You must install the Solaris operating environment and the Sun Remote System Control software prior to setting up an RSC console. For more information, see “About Sun Remote System Control Software” on page 150.

Once you install the operating environment and the RSC software, you can then configure the system to use RSC as the system console. For detailed instructions, see “How to Redirect the System Console to RSC” on page 58.

Configuration Rules

- The RSC card is installed in a dedicated slot at the base of the system I/O board. Never move the RSC card to another system slot, as it is *not* a PCI-compatible card.

Note – The RSC card is *not* a hot-pluggable component. Before installing or removing an RSC card, you must power off the system and disconnect all system power cords.

Note – All internal options (except disk drives and power supplies) must be installed only by qualified service personnel. For information about installing or removing the RSC card, see the *Sun Fire 880 Server Service Manual*, which is included on the Sun Fire 880 Documentation CD.

About Power Supplies

A central power distribution board delivers DC power to all internal system components. The system's power supplies plug in to connectors on this board, and all of the supplies installed share equally in satisfying the power demands of the system.

Sun Fire 880 power supplies are modular units, designed for fast, easy installation or removal, even while the system is fully operational. Power supplies are installed in bays at the rear of the system, as shown in the following figure.

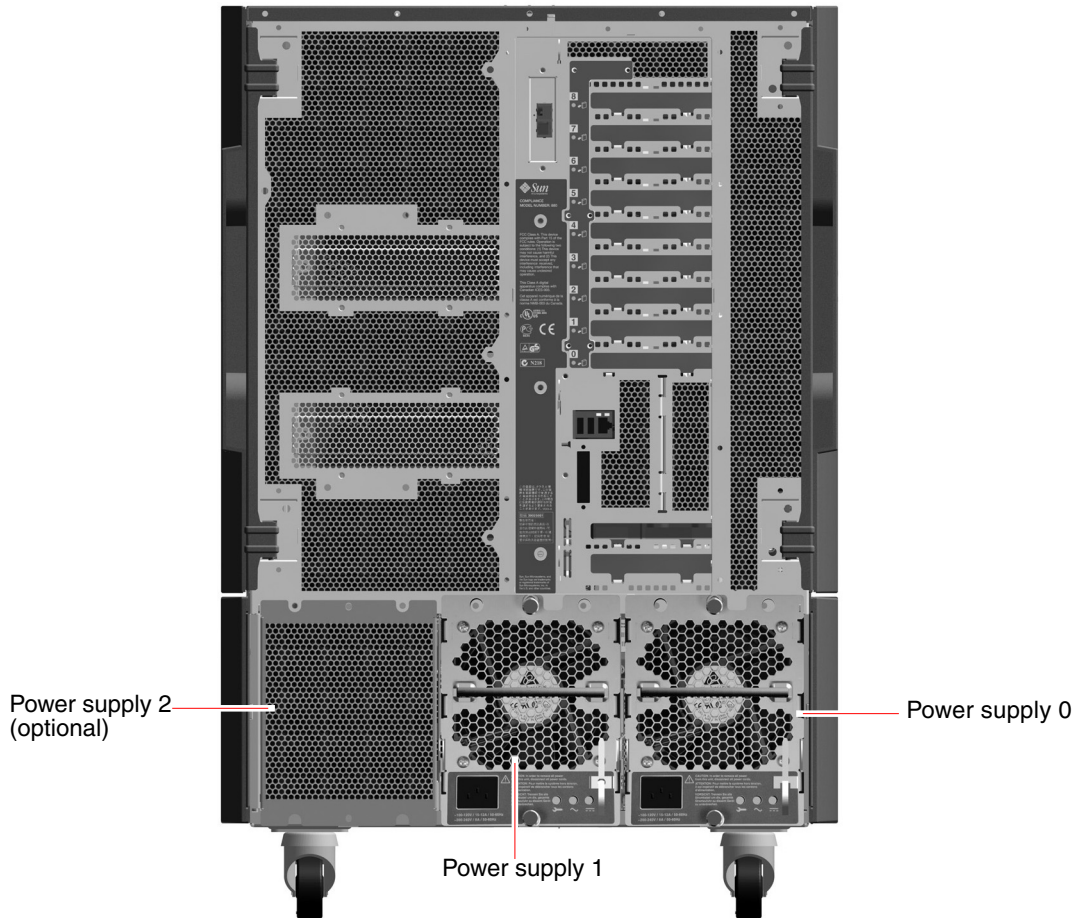

The system can accommodate a maximum of three power supplies, each with its own 20-amp AC power cord. Each power supply is auto-ranging, providing up to 1120 watts of DC power at 120/240 VAC line input. The basic system configuration comes with two power supplies installed, which together provide sufficient power for a maximally configured system. You can add an optional third power supply to provide N+1 power redundancy, allowing the system to continue operating should any one of the power supplies fail.

Each power supply provides a total of five DC output voltages (3.3V, 5.0V, 12V, 48V, and 5.0V standby). Output current is shared equally between each of the supplies via active current sharing circuitry.

Power supplies in a redundant configuration feature a hot-swap capability. You can remove and replace a faulty power supply without shutting down the operating system or turning off the system power. For additional details, see “About Hot-Pluggable and Hot-Swappable Components” on page 144.

Each power supply has three status LEDs to provide power and fault status information. For additional details, see “About Power Supply LEDs” on page 163.

Configuration Rules

- Sun Microsystems recommends that you connect each power supply to a dedicated AC circuit. Consult your local electrical codes for any additional requirements.
- The minimum system configuration requires two power supplies. Systems configured with only one power supply are not supported.
- A system configured with two power supplies may shut down abruptly if either power supply fails. Installation of an optional third power supply enables the system to remain fully operational should any one of the power supplies fail.
- Power supply bays 0 and 1 must always contain power supplies. If a power supply in either bay fails and the system can continue to operate, you must leave the failed power supply in its bay until you are able to install a functioning replacement power supply. A failed power supply in bay 0 or 1 still acts as an air baffle, channeling airflow to cool the bottom row of disk drives in the disk cage. The failed power supply should be replaced as soon as possible to regain N+1 power redundancy.



Caution – If any power supply fails, leave the supply in its bay until you are ready to install a replacement.

For information about installing power supplies, see “How to Install a Power Supply” on page 39.

About Fan Trays

The basic system is equipped with three fan trays: a CPU fan tray, an I/O fan tray, and a motherboard fan tray. The CPU and I/O fan trays contain two fans apiece, while the motherboard fan tray contains a single fan. All systems are equipped with this primary set of fan trays. Systems configured with the redundant cooling option include a secondary set of the same fan trays.

Note – The motherboard fan tray is also known as the I/O bridge fan tray since its primary purpose is to cool the I/O bridge chips on the system motherboard.

The following table describes the system's fan trays.

Fan(s)	Bay No.	Description
Primary CPU fan tray	1	One fan tray with two 6-inch fans
Secondary CPU fan tray	2	One fan tray with two 6-inch fans
Primary I/O fan tray	3	One fan tray with two 4-inch fans
Secondary I/O fan tray	4	One fan tray with two 4-inch fans
Primary motherboard fan tray	5	One 3-inch fan
Secondary motherboard fan tray	6	One 3-inch fan

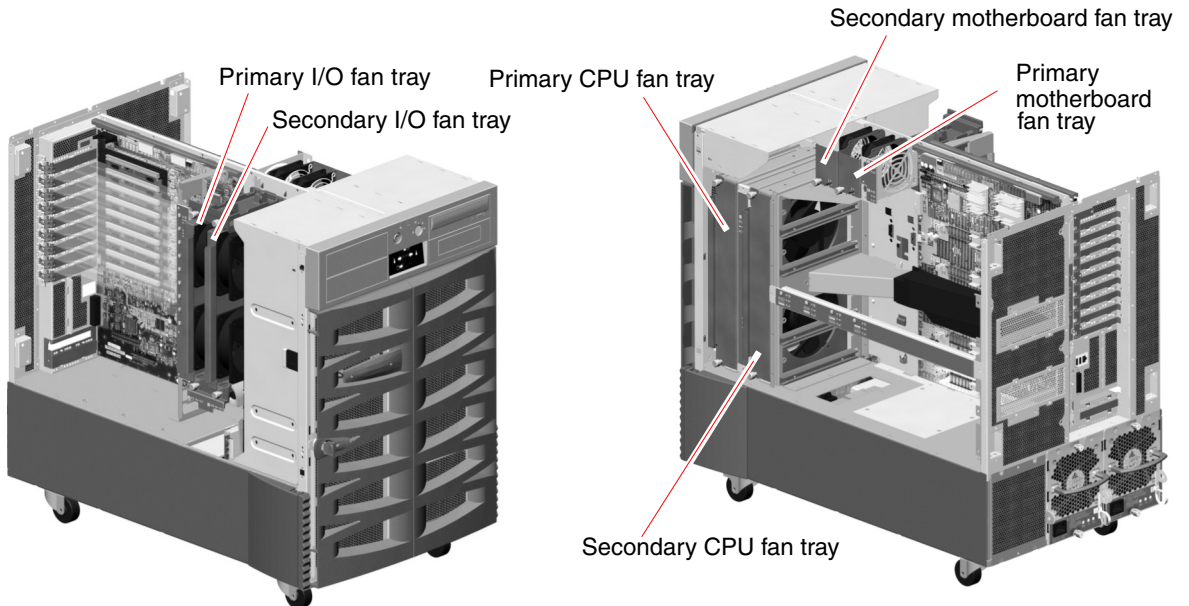

In systems configured with the redundant cooling option, only the primary fan trays are running during normal system operation. If a primary fan tray fails, the environmental monitoring subsystem detects the failure and automatically activates the secondary fan tray.

All fan trays feature a hot-swap capability. You can remove and replace a faulty fan tray without shutting down the operating system or turning off the system power. For additional details, see “About Hot-Pluggable and Hot-Swappable Components” on page 144.

For each fan in the system, the environmental monitoring subsystem monitors or controls the following:

- Fan present (monitored)
- Fan speed in revolutions per minute (RPM) (monitored) – Used to detect early fan degradation
- Fan power input (controlled) – Used to increase or decrease the airflow and cooling capacity
- Fan fault LEDs (controlled)

Only the primary CPU fans have variable speed control. The secondary CPU fans, the primary and secondary motherboard fans, and the primary and secondary I/O fans can only be turned fully on or fully off. Fan speed is controlled by the environmental monitoring subsystem in response to temperature conditions inside the system. For additional details, see “Environmental Monitoring and Control” on page 16.

Status indicator LEDs provide power, fault, and hot-plug indications for each fan tray. For information about the status indicator LEDs, see “About Fan Tray LEDs” on page 164.

Note – All internal options (except disk drives and power supplies) must be installed only by qualified service personnel. For information about installing or removing fan tray assemblies, see the *Sun Fire 880 Server Service Manual*, which is included on the Sun Fire 880 Documentation CD.

Configuration Rules

- The minimum system configuration requires a complete set of three working fan trays — an I/O fan tray, a CPU fan tray, and a motherboard fan tray.
- If the system does not include a secondary CPU fan tray, a CPU fan tray filler panel must be installed in its place.



Caution – A complete set of three working fan trays must be present in the system at all times. After removing a fan tray, if the system is left with fewer than three working fan trays, you must install a replacement fan tray immediately to avoid an automatic thermal shutdown. For more information, see “Environmental Monitoring and Control” on page 16.

About Removable Media Devices

The Sun Fire 880 system provides front-panel access to three mounting bays for 5.25-inch half-height (1.6-inch) SCSI devices. One of the bays houses a SCSI DVD-ROM drive, which comes standard in all system configurations. You can use the other two bays for wide (68-pin) or narrow (50-pin) SCSI tape drives, such as 8-mm tape, 4-mm DDS-2 or DDS-3 tape, or quarter-inch cassette tape drives. Narrow SCSI devices require a 68-pin to 50-pin SCSI adapter (Sun part number X913A), which must be ordered separately. You can easily convert these same two bays into a single full-height bay by removing a metal shelf divider.

The SCSI bus that supports the removable media devices is Fast/Wide-capable (20 Mbytes per second) and can support single-ended, wide or narrow SCSI devices.

Target addresses (also known as SCSI IDs) for the SCSI bus are available in the ranges of 0 through 5 and 8 through 15.

The following target addresses are reserved for internal devices.

Address	Device	Comment
5	Tape drive	If no tape drive is installed in the system, you can use this address for an external device. If you later install an internal tape drive, you must use 5 as its address and assign a different address to the external device.
6	DVD-ROM	This address is reserved exclusively for the DVD-ROM drive. It cannot be used for any other device.
7	SCSI host adapter	This address is reserved exclusively for the SCSI host adapter on the system's motherboard. It cannot be used for any other device.

Configuration Rules

You cannot assign target addresses 6 or 7 to any SCSI removable media device; they are reserved for the system's DVD-ROM drive and SCSI host adapter.

Note – All internal options (except disk drives and power supplies) must be installed only by qualified service personnel. For information about installing or removing removable media devices, see the *Sun Fire 880 Server Service Manual*, which is included on the Sun Fire 880 Documentation CD.

About the Serial Ports

The system provides two serial communication ports through a single, shared DB-25 connector located on the rear panel. The primary port is capable of both synchronous and asynchronous communication, while the secondary port is asynchronous only. In synchronous mode, the primary port operates at any rate from 50 Kbaud to 256 Kbaud when the clock is generated internally. When the clock is generated from an external source, the synchronous port operates at rates up to 384 Kbaud. In asynchronous mode, either port supports baud rates of 50, 75, 110, 200, 300, 600, 1200, 1800, 2400, 4800, 9600, 19200, 38400, 57600, 76800, 115200, 153600, 230400, 307200, and 460800.

The primary port is accessible by connecting a standard serial cable to the rear panel serial port connector. To access the secondary port, you must attach a serial port splitter cable (Sun part number X985A) to the rear panel serial port connector. The connector labeled “A” on the splitter cable provides the primary port; the connector labeled “B” provides the secondary port.

You can configure both serial ports to comply with the Electronics Industries Association EIA-423 or EIA-232D standards using jumpers located on the system’s I/O board. The jumpers are factory-set for the EIA-423 standard, which is the default standard for North American users. Compliance with the EIA-232D standard is required for digital telecommunication in nations of the European Community. For more information about configuring the serial port jumpers, see “About Serial Port Jumpers” on page 82.

See “Reference for Serial Port A and B Connectors” on page 188 for the connector diagram, rear panel icon, and pin assignments.

About the USB Ports

The system's rear panel provides two Universal Serial Bus (USB) ports for connection to USB peripheral devices such as:

- Sun Type 6 USB keyboard
- Sun USB three-button mouse
- Modems
- Printers
- Scanners
- Digital cameras

For USB port locations, see "Locating Rear Panel Features" on page 8.

Note – For Sun Fire 880 servers, you must order the keyboard and mouse as options. If the version of your Sun Type 6 keyboard does not have an integrated USB hub, the keyboard and mouse will consume both USB ports on the system rear panel. If you need to connect additional USB devices, you must add a USB hub.

The USB ports are compliant with the Open Host Controller Interface (Open HCI) specification for USB Revision 1.0. Both ports support isochronous and asynchronous modes and enable data transmission at speeds of 1.5 Mbps and 12 Mbps. Note that the USB data transmission speed is significantly faster than that of the standard serial ports, which operate at a maximum rate of 460 Kbaud.

The USB ports are accessible by connecting a USB cable to either rear panel USB connector. The connectors at each end of a USB cable are different, so you cannot connect them incorrectly. One connector plugs in to the system or USB hub; the other plugs in to the peripheral device. Up to 126 USB devices can be connected to the bus simultaneously, through the use of USB hubs.

Note – The Universal Serial Bus provides power for smaller USB devices such as modems. Larger USB devices, such as scanners, require their own power source.

Both USB ports support hot-plugging. You can connect and disconnect the USB cable and peripheral devices while the system is running, without affecting system operations.

Note – You can only perform USB hot-plug operations while the operating system is running. USB hot-plug operations are not supported when the system ok prompt is displayed.

About Hardware Jumpers

The hardware jumpers in the Sun Fire 880 server have the following functions:

- J2902 and J2903 on the system I/O board are used to configure the serial ports for either EIA-423 or EIA-232D operation. For information about the EIA-423 and EIA-232D jumper settings, see “About Serial Port Jumpers” on page 82.
- J3002, J3003, and J3004 are used to affect the operation of the OpenBoot flash PROM located on the system I/O board. See “About Flash PROM Jumpers” on page 83.
- J01701, J01003, and J0803 are used to affect the operation of the flash PROM located on the FC-AL disk backplane. See “About Flash PROM Jumpers” on page 83.
- J0403 is used to affect the operation of the FRU SEEPROM located on the RSC card. See “About Flash PROM Jumpers” on page 83.

Note – All internal jumper modifications must be performed only by qualified service personnel.

Note – Do not change the configuration of J0501 and J0502 on the RSC card from the default settings; otherwise, the RSC card will not boot.

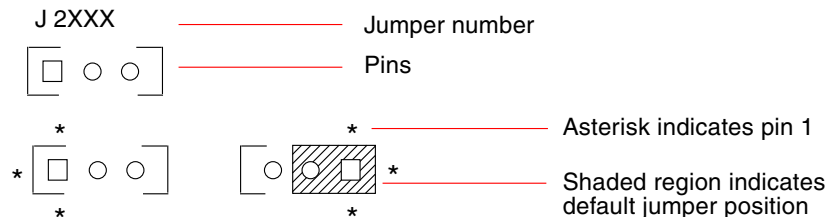

All jumpers are marked with identification numbers. For example, the serial port jumpers on the system I/O board are marked J2902 and J2903. Jumper pins are located immediately adjacent to the identification number. The default jumper positions are indicated with shaded regions. Pin 1 is marked with an asterisk (*) in any of the positions shown below.

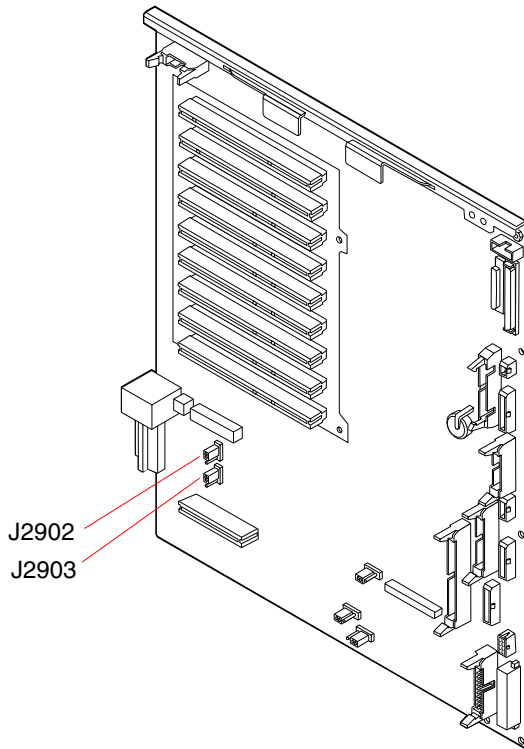

About Serial Port Jumpers

The serial port jumpers (J2902 and J2903) on the system I/O board configure the system's two serial ports for either EIA-423 or EIA-232D signal levels. EIA-423 levels are the default standard for North American users. EIA-232D levels are required for digital telecommunication in nations of the European Community.



Jumper		Shunt on Pins 1 + 2 Selects	Shunt on Pins 2 + 3 Selects	Default Setting
J2902		EIA-232D	EIA-423	2 + 3
J2903		EIA-232D	EIA-423	2 + 3

About Flash PROM Jumpers

The Sun Fire 880 system uses flash PROMs to enable the reprogramming of specific firmware code blocks held in nonvolatile system memory, and to enable remote reprogramming of that code by an authorized system administrator over a local area network. Firmware updates, when required, are available for download from the SunSolveSM Online web site at the following URL:

`http://sunsolve.sun.com`



Instructions for performing a firmware update procedure are provided with the downloaded firmware image.

Several jumpers located on the system I/O board, FC-AL disk backplane, and RSC card affect flash PROM operation. The jumper locations and settings are provided in the sections that follow. For an explanation of how each jumper affects the flash PROM update procedure, see the instructions supplied with the firmware image.

System I/O Board

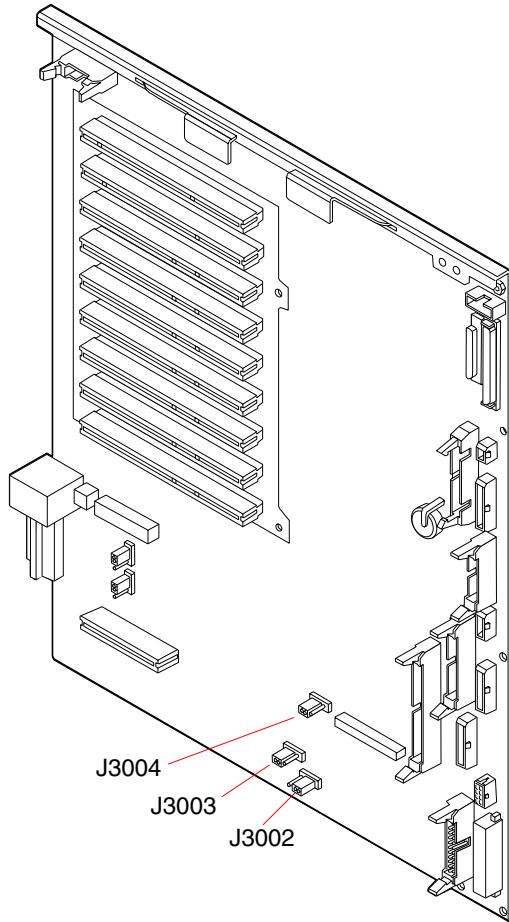
The locations and functions of the flash PROM jumpers on the system I/O board are shown below.



Jumper	Shunt on Pins 1 + 2 Selects	Shunt on Pins 2 + 3 Selects	Default Setting
J3004 	OpenBoot Flash PROM	For factory use only	1 + 2
J3003 	Write-protect	Write-enable	2 + 3
J3002 	High half booting	Normal booting	2 + 3

Note – Jumper J3003 is factory-set so that the flash PROM is write-enabled. You use the keyswitch located on the front panel to write-protect the flash PROM. When the switch is set to the Locked position, the flash PROM is write-protected. When the switch is set to the Normal position or to the Diagnostics position, the flash PROM is write-enabled.

FC-AL Disk Backplane

The locations and functions of the flash PROM jumpers on the Fibre Channel-Arbitrated Loop (FC-AL) disk backplane are shown below.

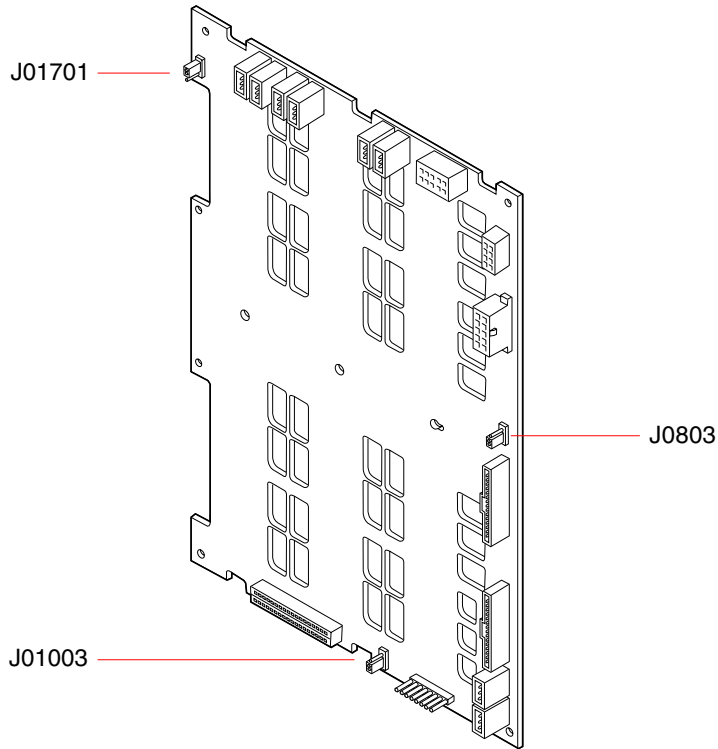



Jumper	Shunt on Pins 1 + 2 Selects	Shunt on Pins 2 + 3 Selects	Default Setting	
J01701		High half booting, Loop B	Normal booting, Loop B	2 + 3
J0803		High half booting, Loop A	Normal booting, Loop A	2 + 3
J01003		Flash PROM	For factory use only	1 + 2

RSC Card

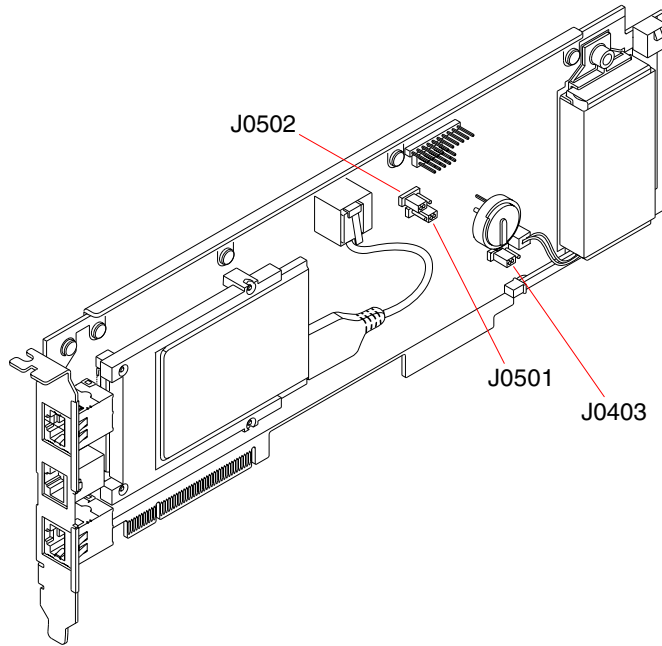
The locations and functions of the flash PROM jumpers on the Remote System Control (RSC) card are shown below.



Jumper	Shunt on Pins 1 + 2 Selects	Shunt on Pins 2 + 3 Selects	Default Setting
J0502 	Not used	Disable mirror	2 + 3
J0501 	Normal booting	Not used	1 + 2
J0403 	FRU PROM write-enable	FRU PROM write-protect	1 + 2

Note – Do not change the configuration of J0501 and J0502 from the default settings; otherwise, the RSC card will not boot.

Mass Storage Subsystem Configuration

This chapter describes the features of the Sun Fire 880 mass storage subsystem, its components, and supported configurations. The following topics covered in this chapter:

- “About FC-AL Technology” on page 90
- “About Sun Fire 880 Mass Storage Features” on page 92
- “About the Mass Storage Subsystem Components” on page 94
- “About the FC-AL Disk Backplanes” on page 95
- “About Internal Disk Drives” on page 97
- “About FC-AL Host Adapters” on page 99
- “About FC-AL Device Addresses” on page 101

About FC-AL Technology

Fibre Channel (FC) is a high-performance serial interconnect standard designed for bidirectional, point-to-point communication among servers, storage systems, workstations, switches, and hubs.

Fibre Channel-Arbitrated Loop (FC-AL) is an important enhancement to the FC standard, developed specifically to meet the needs of storage system interconnects. Employing a simple loop topology, FC-AL can support both simple configurations and complex arrangements of hubs, servers, and storage systems.

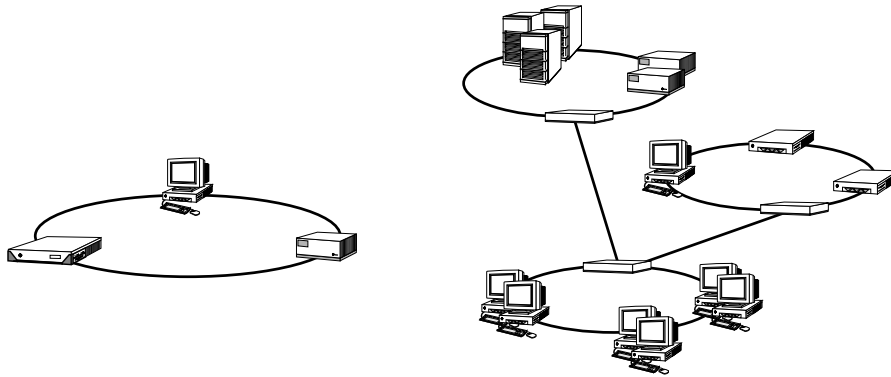

FC-AL devices employ a high-performance Gigabit serial interface, which supports multiple standard protocols such as Small Computer Systems Interface (SCSI) and Asynchronous Transfer Mode (ATM). By supporting these standard protocols, FC-AL preserves any investment in existing legacy systems, firmware, applications, and software.

The unique features of FC-AL provide many advantages over other data transfer technologies. The following table lists the features and advantages of FC-AL. For additional information about FC-AL technology, visit the Fibre Channel Association web site at www.fibrechannel.com.

FC-AL Features	Advantages
Supports 100-Mbyte per second data transfer rate (200 Mbytes per second with dual porting)	High throughput meets the demands of current generation high-performance processors and disks.
Capable of addressing up to 127 devices per loop (controlled by a single controller) ¹	High connectivity controlled by one device allows flexible and simpler configurations.
Supports distances up to 10 km between devices using fiber optic cable (up to 30 meters using copper cable)	Long distances between devices offers improved data availability by allowing remote mirroring and campus clustering.
Provides for reliability, availability, and serviceability (RAS) features such as hot-pluggable and dual-ported disks, redundant data paths, and multiple host connections	RAS features provide improved fault tolerance and data availability.
Supports standard protocols such as IP and SCSI	Migration to FC-AL produces small or no impact on software and firmware.
Implements a simple serial protocol over copper or fiber cable	Configurations that use serial connections are less complex because of the reduced number of cables per connection.
Supports redundant arrays of independent disks (RAID)	RAID support enhances data availability.

1. The 127 supported devices include the FC-AL controller required to support each arbitrated loop.

About Sun Fire 880 Mass Storage Features

The FC-AL technology implemented in the Sun Fire 880 mass storage subsystem significantly enhances the server's reliability, availability, and serviceability (RAS) and performance capabilities.

The following table describes Sun Fire 880 mass storage subsystem features that enhance RAS capabilities.

Features	RAS Capabilities
Dual-ported FC-AL disk drives, dual-loop backplanes, and multiple FC-AL host adapters	These features provide fault tolerance and high availability of data. You can implement automatic failover by configuring two independent and redundant data paths using two FC-AL host adapters and appropriate multipathing software. If a component in either path fails, the software automatically detects the failure and switches all data transfers to the alternate path. For additional details, see "About Multipathing Software" on page 148.
Support for RAID software	Using a software RAID application (Solstice DiskSuite or VERITAS Volume Manager), you can ensure high availability of data through fault tolerance and data redundancy. For more information, see "About Volume Management Software" on page 152.
Hot-pluggable disk drives	Hot-pluggable disk drives ensure high data availability and enhanced serviceability. You can quickly replace a failed disk drive in a powered-on system, without affecting the rest of the system's capabilities. For more information, see "About Internal Disk Drives" on page 97 and "About Hot-Pluggable and Hot-Swappable Components" on page 144.

The following table describes the performance features of the Sun Fire 880 mass storage subsystem.

Features	Performance Enhancements
Dual-ported FC-AL disk drives, dual-loop backplanes, and multiple FC-AL host adapters	These features enable simultaneous access to the internal storage array via two separate loops. When combined with the Dynamic Multipathing (DMP) feature of VERITAS Volume Manager, maximum disk I/O throughput is effectively doubled from 100 to 200 Mbytes per second. DMP automatically balances the I/O load across multiple data paths to the system's internal or external storage arrays. For additional details, see "About the FC-AL Disk Backplanes" on page 95 and "About Volume Management Software" on page 152.
Support for RAID levels 0, 0+1, 1+0, and 5	When configured with optional RAID software, the Sun Fire 880 system supports RAID levels 0, 0+1, 1+0, and 5, which incorporate disk striping. Disk striping distributes contiguous blocks of data across multiple disks. This speeds up data access by enabling multiple disk controllers to access the data simultaneously. For additional information, see "About Volume Management Software" on page 152.

About the Mass Storage Subsystem Components

All Sun Fire 880 servers include the following mass storage subsystem components.

Component	Quantity	Description
FC-AL disk backplane	1	Base backplane providing connections for up to six dual-ported FC-AL disk drives. See "About the FC-AL Disk Backplanes" on page 95.
On-board FC-AL host adapter	1	Integrated into the system motherboard. Manages FC-AL I/O operations and data transfers on loop A of the mass storage subsystem. See "About FC-AL Host Adapters" on page 99.

The following mass storage subsystem components are available as system options.

Component	Quantity	Description
Expansion FC-AL disk backplane	1	Expands the base array to accommodate up to 12 disks. See "About the FC-AL Disk Backplanes" on page 95.
FC-AL disk drives	Up to 12 (6 per backplane)	Low-profile (1.0-inch) dual-ported disks, available in various storage capacities. See "About Internal Disk Drives" on page 97.
PCI FC-AL host adapter cards	Up to 9	PCI host adapter cards for controlling internal or external FC-AL devices. These plug in to PCI slots on the system I/O board. Only one PCI FC-AL host adapter can be connected internally to manage FC-AL I/O operations and data transfers on loop B of the mass storage subsystem. See "About FC-AL Host Adapters" on page 99.

About the FC-AL Disk Backplanes

All Sun Fire 880 servers include a single FC-AL disk backplane with connections for up to six disks. An optional expansion backplane may be installed above the base backplane to accommodate up to six additional disks.

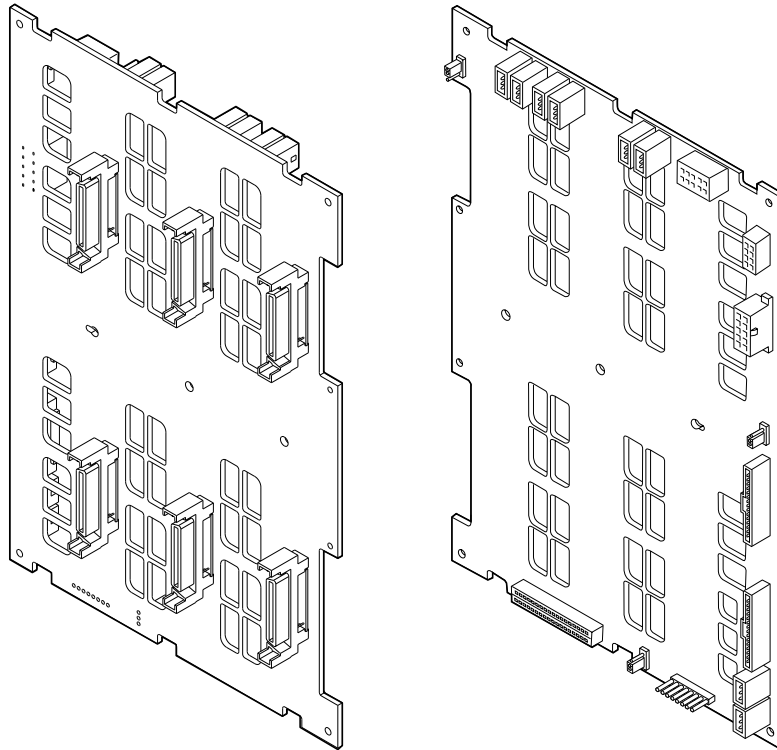

Front view

Rear view

The FC-AL backplane accepts low-profile (1.0-inch) dual-ported FC-AL disk drives. Each disk drive connects to the backplane via a standard 40-pin single connector attachment (SCA) interface. Incorporating all power and signal connections into a single, blind-mating connector, SCA technology makes it easy to add or remove disk drives from the system. Disks using SCA connectors provide higher availability and better serviceability than disks using other types of connectors.

The FC-AL disk backplane provides dual-loop access to all internal disk drives. Dual-loop configurations enable each disk drive to be accessed through two separate and distinct data paths. This capability provides:

- *Increased bandwidth* – Allowing data transfer rates up to 200 Mbytes per second versus 100 Mbytes per second for single-loop configurations
- *Hardware redundancy* – Providing the ability to sustain component failures in one path by switching all data transfers to an alternate path

For more information on the RAS and performance capabilities of the mass storage subsystem, see “About Sun Fire 880 Mass Storage Features” on page 92.

Note – To take advantage of the dual-loop capability of the FC-AL backplanes, an optional PCI FC-AL host adapter card must be installed to control the second loop (Loop B). For more information, see “About FC-AL Host Adapters” on page 99.

Port bypass controllers (PBCs) on the disk backplane ensure loop integrity. When a disk or external device is unplugged or fails, the PBCs automatically bypass the device, closing the loop to maintain data availability.

Each backplane also includes two integrated SSC-100 SCSI Enclosure Services (SES) processors, one for each loop. The SES processors:

- Interpret enclosure service commands from the host software
- Manage the backplane’s FC-AL loop configuration
- Monitor status signals from disks and disk backplanes
- Control disk status LEDs

When a second backplane is installed to form an expanded 12-disk array, only the SES processors on the base backplane are active; the SES processors on the upper backplane remain inactive.

Configuration Rules

- The FC-AL disk backplane requires low-profile (1.0-inch) disk drives.
- The optional expansion disk backplane is installed above the base backplane.

Note – All internal options (except disk drives and power supplies) must be installed only by qualified service personnel. For information about installing or removing an FC-AL disk backplane, see the *Sun Fire 880 Server Service Manual*, which is included on the Sun Fire 880 Documentation CD.

About Internal Disk Drives

The Sun Fire 880 mass storage subsystem accommodates up to 12 low-profile (1.0-inch) FC-AL disk drives. Disks are available in storage capacities of 18.2, 36.4, or 72.8 Gbytes. The maximum internal storage capacity is 873 Gbytes (using twelve 72.8-Gbyte disks), with larger amounts possible as disk storage capacities continue to grow.



All Sun Fire 880 disk drives are dual-ported for multipath access. When used in a dual-loop configuration, each drive can be accessed through two separate and distinct data paths. Dual data paths provide the following benefits:

- *Increased bandwidth* – Allowing data transfer rates up to 200 Mbytes per second versus 100 Mbytes per second for single-loop configurations
- *Hardware redundancy* – Providing the ability to sustain component failures in one path by switching all data transfers to an alternate path

For more information on the RAS and performance capabilities of the mass storage subsystem, see “About Sun Fire 880 Mass Storage Features” on page 92.

Sun Fire 880 disk drives are hot-pluggable. You can add, remove, or replace disks while the system continues to operate. This capability significantly reduces system down-time associated with disk drive replacement. Disk drive hot-plug procedures involve software commands for preparing the system prior to removing a disk drive and for reconfiguring the operating environment after installing a drive. For additional details, see:

- “About Hot-Pluggable and Hot-Swappable Components” on page 144
- “How to Install a Disk Drive” on page 33
- “How to Remove a Disk Drive” on page 36

At the front of the system disk cage are several disk drive status LEDs. There are three LEDs associated with each drive, indicating the drive's operating status, hot-plug readiness, and any fault conditions associated with the drive. These status LEDs help administrators to quickly identify drives requiring service. For additional details, see "About Disk Drive LEDs" on page 166.

The following figure shows the system's 12 internal disk slots and associated LEDs. Disk slots are labeled from 0 to 11.

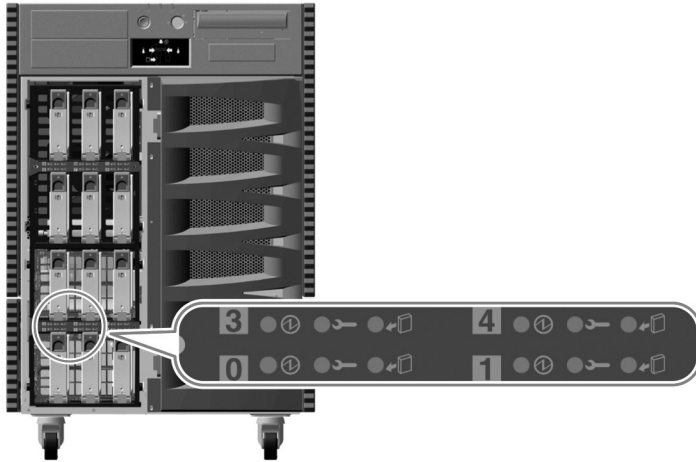

Configuration Rules

- Disk drives must be Sun standard FC-AL disks with low-profile (1.0-inch) form factors.

About FC-AL Host Adapters

The Sun Fire 880 server uses a Qlogic ISP2200A intelligent Fibre Channel processor as its on-board FC-AL controller. Integrated into the system motherboard, the ISP2200A resides on PCI Bus A and supports a 64-bit, 66-MHz PCI interface. The on-board FC-AL controller controls FC-AL operations on Loop A of the base backplane (and the upper backplane when the two are joined as an expanded array).

To take advantage of the dual-loop capability of the FC-AL backplanes, an optional PCI FC-AL host adapter card is required to control the second loop (Loop B). For this purpose, Sun offers the Sun StorEdge PCI Dual Fibre Channel Host Adapter card. This card provides two separate FC-AL channels, each controlled by a Qlogic ISP2200A processor. Each channel provides an external port for connection to external Fibre Channel devices. One of the channels also provides an internal port for connection to the Loop B port on the base FC-AL disk backplane. If the internal port is used, external Port 1 is unavailable for connection to external devices.

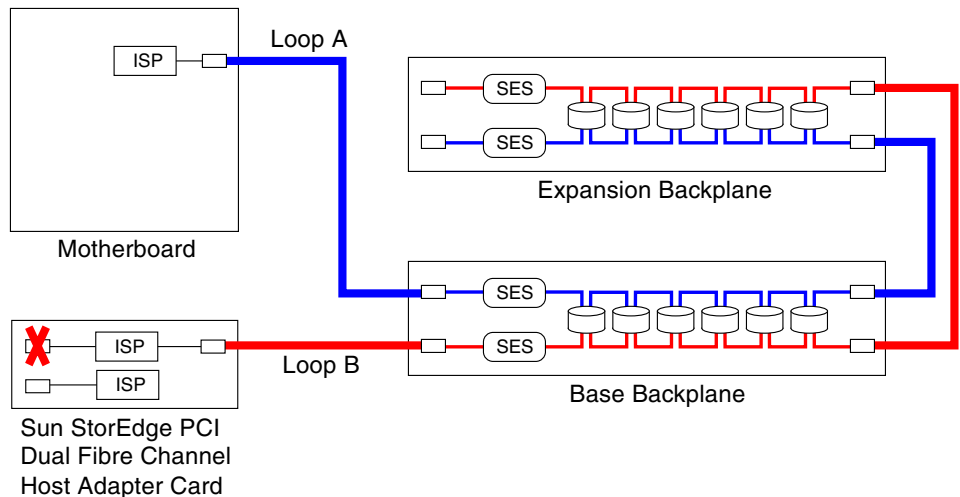

A variety of PCI FC-AL host adapter cards are available from Sun Microsystems and other vendors for controlling external FC-AL devices. These include dual-channel cards and combination cards. Dual-channel cards contain two FC-AL controllers for controlling two separate loops with a single card. Combination cards combine an FC-AL controller with a controller of another type (for example, a Gigabit Ethernet controller). For more information, see the documentation supplied with the host adapter card.

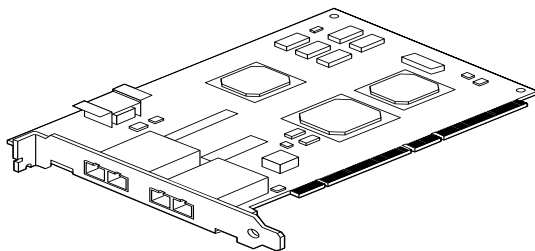

Sun StorEdge PCI Dual Fibre Channel Host Adapter Card

Configuration Rules

- The Sun Fire 880 server supports Sun FC-AL host adapter cards that incorporate the Qlogic ISP2200 series intelligent Fibre Channel processor. Sun host adapter cards that use the Qlogic ISP2100 series processor are not supported. For a list of supported cards, contact your authorized Sun sales representative.
- If your system is configured with a Sun StorEdge PCI Dual Fibre Channel Host Adapter card, and its internal port is connected to the Loop B port of the FC-AL disk backplane, *you must not use the card's external Port 1*. Connecting Port 1 to external devices under these circumstances is considered an unsupported configuration. In this case, use only Port 2 to connect to external devices.
- Do not use the internal port of the Sun StorEdge PCI Dual Fibre Channel Host Adapter card to connect to the Loop A port of the FC-AL disk backplane. You must connect the card's internal port to Loop B only.
- For best performance, install 66-MHz FC-AL host adapter cards in a 66-MHz PCI slot (slot 7 or 8, if available). See "About PCI Cards and Buses" on page 68.

Note – All internal options (except disk drives and power supplies) must be installed only by qualified service personnel. For information about installing or removing a PCI FC-AL host adapter card, see the *Sun Fire 880 Server Service Manual*, which is included on the Sun Fire 880 Documentation CD.

About FC-AL Device Addresses

In a Sun Fire 880 internal storage array, each FC-AL device is assigned a unique selection ID based on its physical location in the storage array. Each slot on the disk backplane is hard-wired to a different selection ID.

Each FC-AL disk drive is connected directly to a Fibre Channel loop and appears as a separate node on the loop. Each node on a loop is assigned a unique arbitrated loop physical address (AL_PA), one of 127 available addresses per loop. AL_PA values may be hard-assigned or soft-assigned and are determined when the loop is initialized—typically when booting the system or when adding or removing a device as part of a hot-plug operation. Hard-assigned AL_PAs are established first, according to the selection ID for each device. If, for any reason, there are conflicts with hard-assigned addresses during loop initialization, the devices involved automatically revert to soft-assigned addresses to resolve the conflicts.

The AL_PA values that are hard-assigned to each device depend upon the device's location within its backplane (disk slot number). The following table shows the selection IDs and AL_PA values that are hard-assigned to Sun Fire 880 internal FC-AL devices, depending on the device location. Both selection IDs and AL_PA values are expressed as hexadecimal numbers.

Base Backplane	Sel ID	AL_PA	Expansion Backplane	Sel ID	AL_PA
Disk 0	00	EF	Disk 6	08	D9
Disk 1	01	E8	Disk 7	09	D6
Disk 2	02	E4	Disk 8	0A	D5
Disk 3	03	E2	Disk 9	0B	D4
Disk 4	04	E1	Disk 10	0C	D3
Disk 5	05	E0	Disk 11	0D	D2
SES processor	06	DC			

Configuring Network Interfaces

This chapter describes the networking options of the system and provides information and instructions required to plan and configure the supported network interfaces.

Tasks covered in this chapter include:

- “How to Configure the Primary Network Interface” on page 106
- “How to Configure Additional Network Interfaces” on page 108
- “How to Attach a Fiber-Optic Gigabit Ethernet Cable” on page 112
- “How to Attach a Twisted-Pair Ethernet Cable” on page 114
- “How to Select the Boot Device” on page 116

Other information covered in this chapter includes:

- “About Network Interface Options” on page 104
- “About Redundant Network Interfaces” on page 105

About Network Interface Options

The Sun Fire 880 server provides two on-board Ethernet interfaces—one Gigabit Ethernet and one Fast Ethernet interface. The 100BASE-TX Fast Ethernet interface is located on the system I/O board and conforms to the IEEE 802.3u Ethernet standard. The Fast Ethernet interface is an auto-sensing, switchable interface that can operate at 100 Mbps or 10 Mbps. It negotiates automatically with the remote end of the link (link partner) to select a common mode of operation.

The 1000BASE-SX Gigabit Ethernet interface resides on the system motherboard and conforms to the IEEE 802.3z Ethernet standard. The Gigabit Ethernet interface operates at 1000 Mbps only.

Two rear panel connectors provide access to the on-board Ethernet interfaces:

- One 1000BASE-SX compliant SC connector for connecting 62.5/125-micron or 50/125-micron fiber-optic cable to the Gigabit Ethernet interface
- One RJ-45 connector for connecting Category-5 twisted-pair Ethernet (TPE) cable to the Fast Ethernet interface

Additional Ethernet interfaces or connections to other network types are available by installing the appropriate PCI interface cards. A Gigabit Ethernet or Fast Ethernet PCI card can serve as a redundant network interface for one of the system's on-board interfaces. If the active network interface becomes unavailable, the system can automatically switch to the redundant interface to maintain availability. This capability is known as automatic failover and must be configured at the Solaris operating environment level. For additional details, see "About Redundant Network Interfaces" on page 105.

The `ge` Gigabit Ethernet driver, the `eri` Fast Ethernet driver, and drivers for several other network interfaces are installed automatically during the Solaris installation procedure. For information about operating characteristics and configuration parameters for the `eri` and `ge` device drivers, see:

- *Platform Notes: The eri FastEthernet Device Driver*
- *Platform Notes: The Sun GigabitEthernet Device Driver*

These documents are available on the *Solaris on Sun Hardware AnswerBook*, which is provided on the Computer Systems Supplement CD for your specific Solaris release.

For instructions on configuring the system's network interfaces, see:

- "How to Configure the Primary Network Interface" on page 106
- "How to Configure Additional Network Interfaces" on page 108

About Redundant Network Interfaces

You can configure your system with redundant network interfaces to provide a highly available network connection. Such a configuration relies on special Solaris software features to detect a failed or failing network interface and automatically switch all network traffic over to the redundant interface. This capability is known as automatic failover.

To set up redundant network interfaces, you can install a pair of identical PCI network interface cards, or add a single card that provides an interface identical to one of the on-board Ethernet interfaces. You can enable automatic failover between the two interfaces using the IP Network Multipathing feature of the Solaris operating environment. For additional details, see “About Multipathing Software” on page 148.

Note – To help maximize system availability, make sure that any redundant network interfaces reside on separate PCI buses, supported by separate PCI bridges. For additional details, see “About PCI Cards and Buses” on page 68.

How to Configure the Primary Network Interface

Before You Begin

You must perform the following tasks:

- Complete the prerequisite steps in “How to Install the Sun Fire 880 Server” on page 25.
- Decide which of the network interfaces you want to use as the primary network interface; see “About Network Interface Options” on page 104.
- Attach a cable to the appropriate network connector on the system rear panel; see “How to Attach a Fiber-Optic Gigabit Ethernet Cable” on page 112 or “How to Attach a Twisted-Pair Ethernet Cable” on page 114. If you are using a PCI network interface card, see the documentation supplied with the card.

What to Do

1. Choose a host name for the system.

The host name must be unique within the network. It can consist of characters and numbers. Do not use a dot in the host name. Do not begin the name with a number or a special character.

2. Determine the unique Internet Protocol (IP) address of the network interface.

An IP address must be assigned by your network administrator. Each network device or interface must have a unique IP address.

3. Resume the installation of the system.

See “How to Install the Sun Fire 880 Server” on page 25.

Note – During installation of the Solaris operating environment, the software automatically detects the system’s on-board network interfaces and any installed PCI network interface cards for which native Solaris device drivers exist. The operating system then asks you to select one of the interfaces as the primary network interface and prompts you for its host name and IP address. You can configure only one network interface during installation of the operating system. You must configure any additional interfaces separately, after the operating system is installed. For more information, see “How to Configure Additional Network Interfaces” on page 108.

What Next

After completing this procedure, the primary network interface is ready for operation. However, in order for other network devices to communicate with the system, you must enter the system’s IP address and host name into the namespace on the network name server. For information about setting up a network name service, consult the *Solaris System Administrator AnswerBook* for your specific Solaris release.

The `eri` and `ge` device drivers for the system’s on-board Ethernet interfaces are automatically installed with the Solaris release. For information about operating characteristics and configuration parameters for these drivers, refer to the following documents:

- *Platform Notes: The eri FastEthernet Device Driver*
- *Platform Notes: The Sun GigabitEthernet Device Driver*

These documents are available on the *Solaris on Sun Hardware AnswerBook*, which is provided on the Computer Systems Supplement CD for your specific Solaris release.

If you want to set up an additional network interface, you must configure it separately, after installing the operating system. See:

- “How to Configure Additional Network Interfaces” on page 108

Note – This system conforms to the Ethernet 10/100BASE-T standard, which states that the Ethernet 10BASE-T link integrity test function should always be enabled on both the host system and the Ethernet hub. If you have problems establishing a connection between this system and your hub, verify that the Ethernet hub also has the link test function enabled. Consult the manual provided with your hub for more information about the link integrity test function.

How to Configure Additional Network Interfaces

Before You Begin

Perform the following tasks to prepare an additional network interface:

- Install the Sun Fire 880 server as described in “How to Install the Sun Fire 880 Server” on page 25.
- If you are setting up a redundant network interface, see “About Redundant Network Interfaces” on page 105.
- If you need to install a PCI network interface card, follow the installation instructions in the *Sun Fire 880 Server Service Manual*. If you are hot-plugging the card, be sure to read “About Hot-Pluggable and Hot-Swappable Components” on page 144.
- Attach a cable to the appropriate network connectors on the system rear panel; see “How to Attach a Fiber-Optic Gigabit Ethernet Cable” on page 112 or “How to Attach a Twisted-Pair Ethernet Cable” on page 114. If you are using a PCI network interface card, see the documentation supplied with the card.

Note – All internal options (except disk drives and power supplies) must be installed by qualified service personnel only. Installation procedures for these components are covered in the *Sun Fire 880 Server Service Manual*, which is included on the Sun Fire 880 Documentation CD.

What to Do

1. Choose a network host name for each new interface.

The host name must be unique within the network. It can consist of characters and numbers. Do not use a dot in the host name. Do not begin the name with a number or a special character.

Usually an interface host name is based on the machine host name. For example, if the machine is assigned the host name `sunrise`, the added network interface could be named `sunrise-1`. The machine’s host name is assigned when Solaris software is installed. For more information, see the installation instructions accompanying the Solaris software.

2. Determine the IP address for each new interface.

An IP address must be assigned by your network administrator. Each interface on a network must have a unique IP address.

3. Boot the operating system (if it is not already running) and log on to the system as superuser.

Be sure to perform a reconfiguration boot if you just added a new PCI network interface card. See “How to Initiate a Reconfiguration Boot” on page 55.

Type the `su` command at the system prompt, followed by the superuser password.

```
$ su
Password:
```

4. Create an appropriate `/etc/hostname` file for each new network interface.

The name of the file you create should be of the form `/etc/hostname.typenum`, where *type* is the network interface type identifier (some common types are `le`, `hme`, `eri`, and `ge`) and *num* is the device instance number of the interface according to the order in which it was installed in the system.

For example, the file names for the system’s on-board Fast Ethernet and Gigabit Ethernet interfaces are `/etc/hostname.eri0` and `/etc/hostname.ge0`, respectively. Both interfaces have a device instance number of 0 since each interface is the first one of its type installed in the system. If you add a PCI Gigabit Ethernet adapter card as a second `ge` interface, its file name should be `/etc/hostname.ge1`. At least one of these files—the primary network interface—should exist already, having been created automatically during the Solaris installation process.

Note – The documentation accompanying the network interface card should identify its type. Alternatively, you can enter the `show-devs` command from the `ok` prompt to obtain a list of all installed devices.

5. Edit the `/etc/hostname` file(s) created in Step 4 to add the host name(s) determined in Step 1.

Following is an example of the `/etc/hostname` files required for a system called `sunrise`, which has two on-board Ethernet interfaces (`ge0` and `eri0`) and a PCI Gigabit Ethernet adapter card (`ge1`). A network connected to the on-board `eri0`

interface will know the system as `sunrise`, while networks connected to the `ge0` and `ge1` interfaces will know the system as `sunrise-1` and `sunrise-2`, respectively.

```
sunrise # cat /etc/hostname.eri0
sunrise
sunrise # cat /etc/hostname.ge0
sunrise-1
sunrise # cat /etc/hostname.ge1
sunrise-2
```

6. Create an entry in the `/etc/hosts` file for each active network interface.

An entry consists of the IP address and the host name for each interface.

The following example shows an `/etc/hosts` file with entries for the three network interfaces used as examples in this procedure.

```
sunrise # cat /etc/hosts
#
# Internet host table
#
127.0.0.1    localhost
129.144.10.57 sunrise loghost
129.144.14.26 sunrise-1
129.144.11.83 sunrise-2
```

7. Manually plumb and enable each new interface using the `ifconfig` command.

For example, for the logical interface `ge0`, type:

```
sunrise # ifconfig ge0 plumb up
```

For more information, see the `ifconfig(1M)` man page.

What Next

After completing this procedure, any new network interfaces are ready for operation. However, in order for other network devices to communicate with the system through the new interface, the IP address and host name for each new interface must be entered into the namespace on the network name server. For information about setting up a network name service, consult the *Solaris System Administrator AnswerBook* for your specific Solaris release.

The `eri` and `ge` device drivers for the system's on-board Ethernet interfaces are automatically installed with the Solaris release. For information about operating characteristics and configuration parameters for these drivers, refer to the following documents:

- *Platform Notes: The eri FastEthernet Device Driver*
- *Platform Notes: The Sun GigabitEthernet Device Driver*

These documents are available on the *Solaris on Sun Hardware AnswerBook*, which is provided on the Computer Systems Supplement CD for your specific Solaris release.

Note – This system conforms to the Ethernet 10/100BASE-T standard, which states that the Ethernet 10BASE-T link integrity test function should always be enabled on both the host system and the Ethernet hub. If you have problems establishing a connection between this system and your Ethernet hub, verify that the hub also has the link test function enabled. Consult the manual provided with your hub for more information about the link integrity test function.

How to Attach a Fiber-Optic Gigabit Ethernet Cable

Before You Begin

Complete the prerequisite steps in:

- “How to Install the Sun Fire 880 Server” on page 25

What to Do

1. Select a fiber-optic cable that meets all Sun Fire 880 cabling requirements.

The Sun Fire 880 on-board Gigabit Ethernet interface supports 50/125-micron or 62.5/125-micron multimode, duplexed, fiber-optic cable. The cable must meet UL910 and UL1651 specifications and must have a standard dual SC connector with a UL94V-2 rating (or better).

Cable lengths must not exceed 300 meters for 62.5/125-micron cable, or 550 meters for 50/125-micron cable.

If your system includes a PCI Gigabit Ethernet adapter card, see the documentation supplied with the card for cable requirements.

2. Locate the dual SC connector for the Gigabit Ethernet interface.

See “Locating Rear Panel Features” on page 8. For a PCI Gigabit Ethernet adapter card, see the documentation supplied with the card.

3. Remove any dust covers from the SC connectors.

4. Connect the fiber-optic cable to the Gigabit Ethernet connector and to the Ethernet network.

The cable and connector are keyed for correct mating orientation.

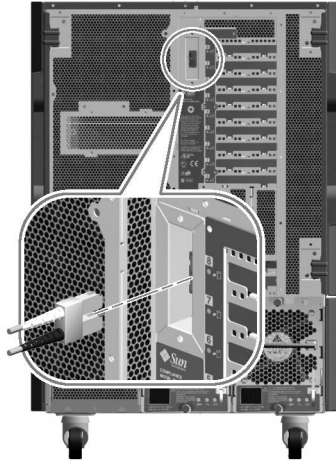

What Next

If you are installing your system, complete the installation procedure. Return to:

- “How to Install the Sun Fire 880 Server” on page 25

If you are adding an additional network interface to the system, then you need to configure that interface. See:

- “How to Configure Additional Network Interfaces” on page 108

How to Attach a Twisted-Pair Ethernet Cable

Before You Begin

Complete the prerequisite steps in:

- “How to Install the Sun Fire 880 Server” on page 25

What to Do

1. **Locate the RJ-45 twisted-pair Ethernet (TPE) connector for the appropriate Fast Ethernet interface.**

See “Locating Rear Panel Features” on page 8. For a PCI Fast Ethernet adapter card, see the documentation supplied with the card.

2. **Plug in a Category-5 unshielded twisted-pair (UTP) cable to the appropriate RJ-45 connector.**

You should hear the connector tab click into place. The UTP cable length must not exceed 100 meters.

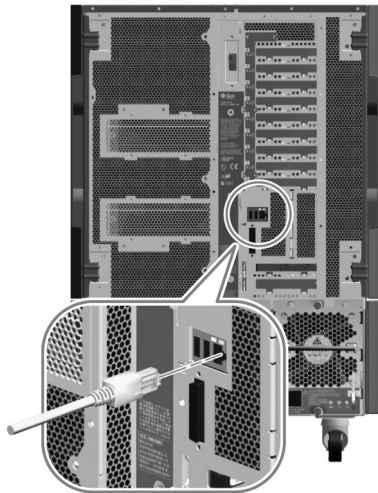

3. Plug the other end of the TPE cable into the RJ-45 outlet to your Fast Ethernet network.

You should hear the connector tab click into place.

See your network administrator if you need more information about how to connect to your network.

What Next

If you are installing your system, complete the installation procedure. Return to:

- “How to Install the Sun Fire 880 Server” on page 25

If you are adding an additional network interface to the system, then you need to configure that interface. See:

- “How to Configure Additional Network Interfaces” on page 108

How to Select the Boot Device

The boot device is specified by the setting of an OpenBoot firmware configuration parameter called `boot-device`. The default setting of this parameter is `disk net`. Because of this setting, the firmware first attempts to boot from the system hard drive, and if that fails, from the on-board Fast Ethernet interface.

Before You Begin

Before you can select a boot device, you must complete the installation procedure; see:

- “How to Install the Sun Fire 880 Server” on page 25

Specifically, you must perform the following tasks:

- Set up a system console; see “About Setting Up a Console” on page 45
- Power on the system; see “How to Power On the System” on page 51

If you want to boot from a network, you must also perform the following tasks:

- Connect the network interface to the network; see “How to Attach a Fiber-Optic Gigabit Ethernet Cable” on page 112 or “How to Attach a Twisted-Pair Ethernet Cable” on page 114
- Configure the network interface; see “How to Configure the Primary Network Interface” on page 106 or “How to Configure Additional Network Interfaces” on page 108

What to Do

This procedure assumes that you are familiar with the OpenBoot firmware and that you know how to enter the OpenBoot environment. For more information about the OpenBoot firmware, see the *OpenBoot 4.x Command Reference Manual* in the *OpenBoot Collection AnswerBook* for your specific Solaris release.

1. At the `ok` prompt, type:

```
ok setenv boot-device device-specifier
```

where the *device-specifier* is one of the following:

- `cdrom` – Specifies the CD-ROM drive
- `disk` – Specifies the system boot disk
- `disk0` – Specifies internal disk 0
- `disk1` – Specifies internal disk 1
- `disk2` – Specifies internal disk 2
- `disk3` – Specifies internal disk 3
- `disk4` – Specifies internal disk 4
- `disk5` – Specifies internal disk 5
- `disk6` – Specifies internal disk 6
- `disk7` – Specifies internal disk 7
- `disk8` – Specifies internal disk 8
- `disk9` – Specifies internal disk 9
- `disk10` – Specifies internal disk 10
- `disk11` – Specifies internal disk 11
- `tape` – Specifies the SCSI tape drive (if present)
- `net` – Specifies the on-board Fast Ethernet interface
- `gem` – Specifies the on-board Gigabit Ethernet interface
- *full path name* – Specifies the device or network interface by its full path name

Note – You can also specify the name of the program to be booted as well as the way the boot program operates. For more information, see the *OpenBoot 4.x Command Reference Manual* in the *OpenBoot Collection AnswerBook* for your specific Solaris release.

If you want to specify a network interface other than an on-board Ethernet interface as the default boot device, you can determine the full path name of each interface by typing:

```
ok show-devs
```

The `show-devs` command lists the system devices and displays the full path name of each PCI device. An example of a path name for a Fast Ethernet PCI card is shown below:

```
/pci@8,700000/pci@2/SUNW,hme@0,1
```

2. To cause parameter changes to take effect, type:

```
ok reset-all
```

Note – To store parameter changes, you can also power cycle the system using the front panel Power button.

What Next

For more information about using the OpenBoot firmware, see the *OpenBoot 4.x Command Reference Manual* in the *OpenBoot Collection AnswerBook* for your specific Solaris release.

Configuring System Firmware

This chapter describes the OpenBoot firmware commands and configuration variables available for configuring the following aspects of Sun Fire 880 system behavior:

- OpenBoot environmental monitoring
- Automatic system recovery (ASR)

In addition, this chapter provides information about keyboard commands and alternative methods for performing OpenBoot emergency procedures.

Tasks covered in this chapter include:

- “How to Enable OpenBoot Environmental Monitoring” on page 122
- “How to Disable OpenBoot Environmental Monitoring” on page 123
- “How to Obtain OpenBoot Environmental Status Information” on page 124
- “How to Enable ASR” on page 130
- “How to Disable ASR” on page 131
- “How to Deconfigure a Device Manually” on page 132
- “How to Reconfigure a Device Manually” on page 134
- “How to Obtain ASR Status Information” on page 136

Other information covered in this chapter includes:

- “About OpenBoot Environmental Monitoring” on page 120
- “About Automatic System Recovery” on page 126
- “About OpenBoot Emergency Procedures” on page 138

Note – The procedures in this chapter assume that you are familiar with the OpenBoot firmware and that you know how to enter the OpenBoot environment. For more information about the OpenBoot firmware, see the *OpenBoot 4.x Command Reference Manual*. An online version of the manual is included with the *OpenBoot Collection AnswerBook* that ships with Solaris software.

About OpenBoot Environmental Monitoring

Environmental monitoring and control capabilities for Sun Fire 880 systems reside at both the operating system level and the OpenBoot firmware level. This ensures that monitoring capabilities are operational even if the system has halted or is unable to boot. Whenever the system is under OpenBoot control, the OpenBoot environmental monitor checks the state of the system power supplies, fans, and temperature sensors every 30 seconds. If it detects any voltage, current, fan speed, or temperature irregularities, the monitor generates a warning message to the system console. In the event of a critical fan failure or overtemperature condition, the monitor generates a shutdown warning and automatically powers off the system after 30 seconds to prevent hardware damage.

For additional information about the system's environmental monitoring capabilities, see "Environmental Monitoring and Control" on page 16.

Enabling or Disabling the OpenBoot Environmental Monitor

The OpenBoot environmental monitor is enabled by default whenever the system is operating at the `ok` prompt. However, you can enable or disable it yourself using the OpenBoot commands `env-on` and `env-off`. For more information, see:

- "How to Enable OpenBoot Environmental Monitoring" on page 122
- "How to Disable OpenBoot Environmental Monitoring" on page 123

Note – Using the Stop-A keyboard command to enter the OpenBoot environment will immediately disable the OpenBoot environmental monitor. If you want the OBP environmental monitor enabled, you must re-enable it prior to rebooting the system. If you enter the OpenBoot environment through any other means — by halting the operating system, by power-cycling the system, or as a result of a system panic — the OpenBoot environmental monitor will remain enabled.

Automatic System Shutdown

If the OpenBoot environmental monitor detects a critical fan failure or overtemperature condition, it will initiate an automatic system shutdown sequence. In this case, a warning similar to the following is generated to the system console:

```
WARNING: SYSTEM POWERING DOWN IN 30 SECONDS!  
Press Ctrl-C to cancel shutdown sequence and return to ok prompt.
```

If necessary, you can type Control-C to abort the automatic shutdown and return to the system ok prompt; otherwise, after the 30 seconds expire, the system will power off automatically.

Note – Typing Control-C to abort an impending shutdown also has the effect of disabling the OpenBoot environmental monitor. This gives you enough time to replace the component responsible for the critical condition without triggering another automatic shutdown sequence. After replacing the faulty component, you must type the `env-on` command to reinstate OpenBoot environmental monitoring.



Caution – If you type Control-C to abort an impending shutdown, you should immediately replace the component responsible for the critical condition. If a replacement part is not immediately available, power off the system to avoid damaging system hardware.

OpenBoot Environmental Status Information

The OpenBoot command `.env` lets you obtain status on the current state of everything of interest to the OpenBoot environmental monitor. You can obtain environmental status at any time, regardless of whether OpenBoot environmental monitoring is enabled or disabled. The `.env` status command simply reports the current environmental status information; it does not take action if anything is abnormal or out of range.

For an example of `.env` command output, see “How to Obtain OpenBoot Environmental Status Information” on page 124.

How to Enable OpenBoot Environmental Monitoring

The OpenBoot environmental monitor is enabled by default whenever the system is operating at the `ok` prompt. However, you can enable or disable it yourself using the OpenBoot commands `env-on` and `env-off`.

Note – The commands `env-on` and `env-off` only affect environmental monitoring at the OpenBoot level. They have no effect on the system's environmental monitoring and control capabilities while the operating system is running.

Before You Begin

This procedure assumes that you are familiar with the OpenBoot firmware and that you know how to enter the OpenBoot environment. For more information about the OpenBoot firmware, see the *OpenBoot 4.x Command Reference Manual* in the *OpenBoot Collection AnswerBook* for your specific Solaris release.

What to Do

- **To enable OpenBoot environmental monitoring, type `env-on` at the system `ok` prompt.**

```
ok env-on
Environmental monitor is ON
ok
```

How to Disable OpenBoot Environmental Monitoring

The OpenBoot environmental monitor is enabled by default whenever the system is operating at the `ok` prompt. However, you can enable or disable it yourself using the OpenBoot commands `env-on` and `env-off`.

Note – The commands `env-on` and `env-off` only affect environmental monitoring at the OpenBoot level. They have no effect on the system’s environmental monitoring and control capabilities while the operating system is running.

Note – Using the Stop-A keyboard command to enter the OpenBoot environment will immediately disable the OpenBoot environmental monitor. You must then re-enable the environmental monitor prior to rebooting the system. If you enter the OpenBoot environment through any other means — by halting the operating system, by power-cycling the system, or as a result of a system panic — the OpenBoot environmental monitor will remain enabled.

What to Do

- **To disable OpenBoot environmental monitoring, type `env-off` at the system `ok` prompt.**

```
ok env-off
Environmental monitor is OFF
ok
```

How to Obtain OpenBoot Environmental Status Information

You can use the OpenBoot command `.env` at the system `ok` prompt to obtain status information about the system's power supplies, fans, and temperature sensors.

What to Do

- To obtain OpenBoot environmental status information, type `.env` at the system `ok` prompt.

```
ok .env
Environmental Status:

Power Supplies:
PS0:                Present, receiving AC power
PS1:                Present, receiving AC power
PS2:                Not Present

Fans:
Tray 1 (CPU):       Present, Fan A @ 3125 RPM, Fan B @ 3333 RPM
Tray 2 (CPU):       Not Present
Tray 3 (I/O):       Present, Fan A @ 2912 RPM, Fan B @ 2830 RPM
Tray 4 (I/O):       Not Present
Fan 5 (I/O Bridge): Present, Fan    @ 3333 RPM
Fan 6 (I/O Bridge): Not Present

Temperatures:
CPU0:               Ambient = 30 deg. C, Die = 53 deg. C
CPU2:               Ambient = 29 deg. C, Die = 41 deg. C
I/O Bridge 0:       Ambient = 29 deg. C, Die = 62 deg. C
I/O Bridge 1:       Ambient = 28 deg. C, Die = 63 deg. C
DAR:                Ambient = 28 deg. C, Die = 69 deg. C
DCS:                Ambient = 28 deg. C, Die = 60 deg. C
MDR8-0:             Ambient = 26 deg. C, Die = 48 deg. C
Motherboard:        Ambient = 26 deg. C
I/O Board:          Ambient = 24 deg. C
Disk Backplane 0:   Ambient = 24 deg. C
Disk Backplane 1:   Ambient = 25 deg. C

Environmental monitor is ON
```

Note – You can obtain environmental status at any time, regardless of whether OpenBoot environmental monitoring is enabled. The `.env status` command simply reports the current environmental status information; it does not take action if anything is abnormal or out of range.

About Automatic System Recovery

The system provides for automatic system recovery (ASR) from the following types of hardware component failures:

- CPUs
- Memory modules
- PCI buses and cards
- SCSI bus
- FC-AL subsystem
- Fast Ethernet interface
- Gigabit Ethernet interface
- USB interface
- Serial interfaces

The automatic system recovery feature enables the system to resume operation after experiencing certain non-fatal hardware faults or failures. When ASR is enabled, the system's firmware diagnostics automatically detect failed hardware components, while an auto-configuring capability designed into the OpenBoot firmware enables the system to deconfigure failed components and restore system operation. As long as the system is capable of operating without the failed component, the ASR features enable the system to reboot automatically, without operator intervention.

During the power-on sequence, if a faulty component is detected, the component is automatically deconfigured and, if the system remains capable of functioning without it, the boot sequence continues. In a running system, certain types of failures (such as a processor failure) can bring the system down. If this happens, the ASR functionality enables the system to reboot immediately if it is possible for the system to function without the failed component. This prevents a faulty hardware component from keeping the entire system down or causing the system to crash repeatedly.

To support such a degraded boot capability, the OpenBoot firmware uses the 1275 Client Interface (via the device tree) to “mark” devices as either *failed* or *disabled*, by creating an appropriate “status” property in the corresponding device tree node. By convention, UNIX will not activate a driver for any subsystem so marked. Thus, as long as the failed component is electrically dormant (that is, it will not cause random bus errors or signal noise, etc.), the system can be rebooted automatically and resume operation while a service call is made.

Note – ASR is not activated until you enable it. See “How to Enable ASR” on page 130.

Auto-Boot Options

The OpenBoot firmware provides an NVRAM controlled switch called `auto-boot?`, which controls whether the firmware will automatically boot the operating system after each reset. The default setting for Sun platforms is `true`.

Normally, if a system fails power-on diagnostics, then `auto-boot?` is ignored and the system does not boot unless an operator boots the system manually. This behavior is obviously not acceptable for a degraded boot scenario. Therefore, the Sun Fire 880 OpenBoot firmware provides a second NVRAM-controlled switch called `auto-boot-on-error?`. This switch controls whether the system will attempt a degraded boot when a subsystem failure is detected. Both the `auto-boot?` and `auto-boot-on-error?` switches must be set to `true` to enable an automatic degraded boot.

```
ok setenv auto-boot? true
ok setenv auto-boot-on-error? true
```

Note – The default setting for `auto-boot-on-error?` is `false`. Therefore, the system will not attempt a degraded boot unless you change this setting to `true`. In addition, the system will not attempt a degraded boot in response to any fatal non-recoverable error, even if degraded booting is enabled. For examples of fatal non-recoverable errors, see “Error Handling Summary” on page 127.

Error Handling Summary

Error handling during the power-on sequence falls into one of the following three cases:

1. If no errors are detected by POST or OpenBoot Diagnostics, the system attempts to boot if `auto-boot?` is `true`.
2. If only non-fatal errors are detected by POST and/or OpenBoot Diagnostics, the system attempts to boot if `auto-boot?` is `true` and `auto-boot-on-error?` is `true`. Non-fatal errors include the following:
 - SCSI bus failure
 - FC-AL subsystem failure – In this case, a working alternate path to the boot disk is required. For more information, see “About Multipathing Software” on page 148.
 - Gigabit Ethernet or Fast Ethernet interface failure
 - USB interface failure

- Serial interface failure
- PCI card failure
- CPU failure – In this case, a single CPU failure causes the entire CPU/Memory board to be deconfigured. Another non-failing CPU/Memory board must be present in the system for the system to attempt a degraded boot.
- Memory failure – Given a failed memory module, the firmware will deconfigure the entire logical bank associated with the failed module. Another non-failing logical bank must be present in the system for the system to attempt a degraded boot.

Note – If POST or OpenBoot Diagnostics detects a non-fatal error associated with the normal boot device, the OpenBoot firmware automatically deconfigures the failed device and tries the next-in-line boot device, as specified by the `boot-device` configuration variable.

3. If a fatal error is detected by POST and/or OpenBoot Diagnostics, the system will not boot regardless of the settings of `auto-boot?` or `auto-boot-on-error?`. Fatal non-recoverable errors include the following:
 - All CPUs failed
 - All logical memory banks failed
 - Flash RAM cyclical redundancy check (CRC) failure
 - Critical FRU PROM configuration data failure
 - Critical application specific integrated circuit (ASIC) failure

Reset Scenarios

Two OpenBoot NVRAM configuration variables, `diag-switch?` and `diag-trigger`, control whether the system runs firmware diagnostics in response to system reset events.

The standard system reset protocol bypasses POST and OpenBoot Diagnostics completely unless the variable `diag-switch?` is set to `true`. The default setting for this variable is `false`. Therefore to enable ASR, which relies on firmware diagnostics to detect faulty devices, you must change this setting to `true`.

To control which reset events, if any, automatically initiate firmware diagnostics, the OpenBoot firmware provides a NVRAM variable called `diag-trigger`. The `diag-trigger` variable, and its various settings are described in the following table.

Setting	Function
<code>power-reset</code> (<i>default</i>)	Runs firmware diagnostics only on power-on resets, including RSC-initiated power on resets.
<code>error-reset</code>	Runs firmware diagnostics only on power-on resets and resets triggered by hardware errors, including operating system panics, and watchdog reset events.
<code>soft-reset</code> (<i>recommended</i>)	Runs firmware diagnostics on all reset events.
<code>none</code>	Disables the automatic triggering of firmware diagnostics by any reset event. You can still invoke firmware diagnostics manually by turning the front panel keyswitch to the Diagnostics position prior to powering on the system.

Note – The `diag-trigger` variable has no effect unless `diag-switch?` is set to `true`.

In the following example, the `diag-switch?` and `diag-trigger` variables are used to trigger POST and OpenBoot Diagnostics on all reset events.

```
ok setenv diag-switch? true
ok setenv diag-trigger soft-reset
```

ASR User Commands

The OpenBoot commands `.asr`, `asr-disable`, and `asr-enable` are available for obtaining ASR status information and for manually deconfiguring or reconfiguring system devices. For more information, see:

- “How to Deconfigure a Device Manually” on page 132
- “How to Reconfigure a Device Manually” on page 134
- “How to Obtain ASR Status Information” on page 136

How to Enable ASR

The automatic system recovery (ASR) feature is not activated until you enable it at the system ok prompt.

What to Do

1. Type the following at the system ok prompt:

```
ok setenv diag-switch? true
ok setenv auto-boot? true
ok setenv auto-boot-on-error? true
```

2. Set the `diag-trigger` variable to `power-reset`, `error-reset`, or `soft-reset`.
Type:

```
ok setenv diag-trigger soft-reset
```

For more information, see “Reset Scenarios” on page 128.

3. To cause the parameter changes to take effect, type:

```
ok reset-all
```

The system permanently stores the parameter changes and then reboots automatically.

Note – To store parameter changes, you can also power cycle the system using the front panel Power button.

How to Disable ASR

What to Do

1. Type the following at the system `ok` prompt:

```
ok setenv auto-boot-on-error? false
```

2. To cause the parameter change to take effect, type:

```
ok reset-all
```

The system permanently stores the parameter change.

Note – To store parameter changes, you can also power cycle the system using the front panel Power button.

How to Deconfigure a Device Manually

To support a degraded boot capability, the OpenBoot firmware provides the `asr-disable` command, which lets you manually deconfigure system devices. This command “marks” a specified device as *disabled*, by creating an appropriate “status” property in the corresponding device tree node. By convention, UNIX will not activate a driver for any device so marked.

What to Do

1. At the `ok` prompt, type:

```
ok asr-disable device-identifier
```

where the *device-identifier* is one of the following:

- Any full physical device path as reported by the OpenBoot `show-devs` command
- Any valid device alias as reported by the OpenBoot `devalias` command
- Any device identifier from the following table

Device Identifiers	Devices
<code>cpu0</code> , <code>cpu1</code> , ... <code>cpu7</code>	CPU 0 – CPU 7
<code>cpu0-bank0</code> , <code>cpu0-bank1</code> , <code>cpu0-bank2</code> , <code>cpu0-bank3</code> , ... <code>cpu7-bank0</code> , <code>cpu7-bank1</code> , <code>cpu7-bank2</code> , <code>cpu7-bank3</code>	Memory banks 0 – 3 for each CPU
<code>gptwo-slotA</code> , <code>gptwo-slotB</code> , <code>gptwo-slotC</code> , <code>gptwo-slotD</code>	CPU/Memory board slots A – D
<code>ob-gem</code>	On-board Gigabit Ethernet controller
<code>ob-fcal</code>	On-board FC-AL controller
<code>ob-scsi</code>	On-board SCSI controller
<code>pci-slot0</code> , <code>pci-slot1</code> , ... <code>pci-slot8</code>	PCI slots 0 – 8
<code>hba8</code> , <code>hba9</code>	PCI bridge chips 0 and 1, respectively

Note – The device identifiers above are not case-sensitive; you can type them as uppercase or lowercase characters.

Note – Manually deconfiguring a single CPU causes the entire CPU/Memory board to be deconfigured, including both CPUs and all memory residing on the board.

You can determine full physical device paths by typing:

```
ok show-devs
```

The `show-devs` command lists the system devices and displays the full path name of each device. An example of a path name for a Fast Ethernet PCI card is shown below:

```
/pci@8,700000/pci@2/SUNW,hme@0,1
```

You can display a list of current device aliases by typing:

```
ok devalias
```

You can also create your own device alias for a physical device by typing:

```
ok devalias alias_name physical_device_path
```

where *alias_name* is the alias that you want to assign, and *physical_device_path* is the full physical device path for the device.

Note – If you manually deconfigure a device alias using `asr-disable`, and then assign a different alias to the device, the device will remain deconfigured even though the device alias has changed.

2. To cause the parameter change to take effect, type:

```
ok reset-all
```

The system permanently stores the parameter change.

Note – To store parameter changes, you can also power cycle the system using the front panel Power button.

How to Reconfigure a Device Manually

You can use the OpenBoot `asr-enable` command to reconfigure any device that you previously deconfigured with `asr-disable`.

What to Do

1. At the `ok` prompt, type:

```
ok asr-enable device-identifier
```

where the *device-identifier* is one of the following:

- Any full physical device path as reported by the OpenBoot `show-devs` command
- Any valid device alias as reported by the OpenBoot `devalias` command
- Any device identifier from the following table

Device Identifiers	Devices
<code>cpu0, cpu1, ... cpu7</code>	CPU 0 – CPU 7
<code>cpu*</code>	All CPUs
<code>cpu0-bank0, cpu0-bank1, cpu0-bank2, cpu0-bank3, ... cpu7-bank0, cpu7-bank1, cpu7-bank2, cpu7-bank3</code>	Memory banks 0 – 3 for each CPU
<code>cpu0-bank*, cpu1-bank*, ... cpu7-bank*</code>	All memory banks for each CPU
<code>gptwo-slotA, gptwo-slotB, gptwo-slotC, gptwo-slotD</code>	CPU/Memory board slots A – D
<code>gptwo-slot*</code>	All CPU/Memory board slots
<code>ob-gem</code>	On-board Gigabit Ethernet controller
<code>ob-fcal</code>	On-board FC-AL controller
<code>ob-scsi</code>	On-board SCSI controller
<code>pci-slot0, pci-slot1, ... pci-slot8</code>	PCI slots 0 – 8
<code>pci-slot*</code>	All PCI slots
<code>pci*</code>	All on-board PCI devices (on-board Gigabit Ethernet, FC-AL, and SCSI controllers) and all PCI slots.
<code>hba8, hba9</code>	PCI bridge chips 0 and 1, respectively
<code>hba*</code>	All PCI bridge chips
<code>*</code>	All devices

Note – The device identifiers are not case-sensitive; you can type them as uppercase or lowercase characters. Also, you can use the wildcard character * only with `asr-enable`; wildcards are not allowed with `asr-disable`.

You can determine which devices are currently disabled by typing:

```
ok .asr
```

See “How to Obtain ASR Status Information” on page 136.

2. To cause the parameter change to take effect, type:

```
ok reset-all
```

The system permanently stores the parameter change.

Note – To store parameter changes, you can also power cycle the system using the front panel Power button.

How to Obtain ASR Status Information

What to Do

- Type the following at the system ok prompt:

```
ok .asr
System ASR Status
Component:      Status

CPU0/Memory:    Enabled
CPU1:           Enabled
Memory Bank0:   Disabled
Memory Bank1:   Disabled
Memory Bank2:   Disabled
Memory Bank3:   Disabled
CPU2/Memory:    Enabled
CPU3/Memory:    Enabled
CPU4/Memory:    Enabled
CPU5/Memory:    Enabled
CPU6/Memory:    Enabled
CPU7/Memory:    Enabled
HBA8:           Enabled
HBA9:           Enabled
GPTwo Slot A:   Enabled
GPTwo Slot B:   Enabled
GPTwo Slot C:   Enabled
GPTwo Slot D:   Enabled
Onboard SCSI:   Enabled
Onboard FCAL:   Enabled
Onboard GEM:    Enabled
PCI Slot 0:     Enabled
PCI Slot 1:     Enabled
PCI Slot 2:     Enabled
PCI Slot 3:     Enabled
PCI Slot 4:     Enabled
PCI Slot 5:     Enabled
PCI Slot 6:     Enabled
PCI Slot 7:     Enabled
PCI Slot 8:     Enabled

The following devices have been ASR disabled:
/pci@8,600000/SUNW,qlc@2/fp@0,0/disk@4,0
```

In the .asr command output, any devices marked disabled have been manually deconfigured using the asr-disable command.

In this example, the `.asr` output shows that the following devices have been deconfigured:

- All four memory banks controlled by CPU 1
- The disk drive installed in disk slot 4

Note – The `.asr` command only shows devices that have been manually disabled using the `asr-disable` command. It does not show devices that have been automatically deconfigured as a result of failing firmware diagnostics. To see which devices, if any, have failed POST diagnostics, use the `.post` command, as described in the *Sun Fire 880 Server Service Manual*.

For more information, see:

- “About Automatic System Recovery” on page 126
- “How to Enable ASR” on page 130
- “How to Disable ASR” on page 131
- “How to Deconfigure a Device Manually” on page 132
- “How to Reconfigure a Device Manually” on page 134

About OpenBoot Emergency Procedures

The introduction of Universal Serial Bus (USB) keyboards with the newest Sun systems has made it necessary to change some of the OpenBoot emergency procedures. Specifically, the Stop-N, Stop-D, and Stop-F commands that are available on systems with standard (non-USB) keyboards are not supported on systems that use USB keyboards, such as the Sun Fire 880 system. The following sections describe the OpenBoot emergency procedures for systems with standard keyboards and for newer systems with USB keyboards.

OpenBoot Emergency Procedures for Systems With Standard (non-USB) Keyboards

The following table summarizes the Stop key command functions for systems that use standard (non-USB) keyboards.

Command	Description
Stop	Bypass POST. This command does not depend on security mode. (Note: Some systems bypass POST as a default. In such cases, use Stop-D to start POST.)
Stop-A	Abort.
Stop-D	Enter the diagnostic mode (set <code>diag-switch?</code> to <code>true</code>).
Stop-F	Enter Forth on TTYA instead of probing. Use <code>fexit</code> to continue with the initialization sequence. Useful if hardware is broken.
Stop-N	Reset NVRAM configuration variables to their default values.

OpenBoot Emergency Procedures for Systems With USB Keyboards

The following paragraphs describe how to perform the functions of the Stop commands on systems that use USB keyboards, such as the Sun Fire 880 system.

Stop-A Functionality

Stop-A (Abort) works the same as it does on systems with standard keyboards, except that it does not work during the first few seconds after the machine is reset.

Stop-N Functionality

1. **After turning on the power to your system, wait until the system Fault LED on the front panel begins to blink.**
2. **Press the front panel Power button twice (with a short, one-second delay in between presses).**

A screen similar to the following is displayed to indicate that you have successfully reset the NVRAM configuration variables to the default values:

```
Sun Fire 880 (8 X UltraSPARC-III), Keyboard Present
OpenBoot x.x, 256 MB memory installed, Serial #xxxxxxxx.
Ethernet address xx:xx:xx:xx:xx:xx, Host ID: xxxxxxxx.

Safe NVRAM mode, the following nvram configuration variables have
been overridden:
  'diag-switch?' is true
  'use-nvramrc?' is false
  'input-device', 'output-device' are defaulted
  'ttya-mode', 'ttyb-mode' are defaulted

These changes are temporary and the original values will be
restored after the next hardware or software reset.

ok
```

Note that some NVRAM configuration variables are reset to their defaults. They include variables that are more likely to cause problems, such as TTYA settings. These NVRAM settings are only reset to the defaults for this power cycle. If you do nothing other than reset the system at this point, the values are not permanently changed. Only settings that you change manually at this point become permanent. All other customized NVRAM settings are retained.

Typing `set-defaults` discards any customized NVRAM values and permanently restores the default settings for all NVRAM configuration variables.

Note – Once the front panel LEDs stop blinking and the Power/OK LED stays lit, pressing the Power button again will begin a graceful shutdown of the system.

Stop-F Functionality

The Stop-F functionality is not available in systems with USB keyboards.

Stop-D Functionality

The Stop-D (diags) key sequence is not supported on systems with USB keyboards. However, the Stop-D functionality can be closely emulated by turning the system keyswitch to the Diagnostics position. For more information, see “About the Status and Control Panel” on page 10.

Server Administration

This chapter provides an introduction to server administration tools supported on the Sun Fire 880 system. The following information is covered in this chapter:

- “About Server Administration Software” on page 142
- “About Hot-Pluggable and Hot-Swappable Components” on page 144
- “About Multipathing Software” on page 148
- “About Sun Management Center Software” on page 149
- “About Sun Remote System Control Software” on page 150
- “About Volume Management Software” on page 152
- “About the Solaris luxadm Utility” on page 156
- “About Sun Cluster Software” on page 157

About Server Administration Software

A number of software-based administration tools are available to help you configure your system for performance and availability, monitor and manage your system, and identify hardware problems. These administration tools include:

- Solaris Dynamic Reconfiguration (DR) software
- Multipathing software
- Sun Management Center software
- Sun Remote System Control (RSC) software
- Volume management software
- Solaris luxadm utility
- Sun Cluster software

The following table provides a summary of each tool with a pointer to additional information.

Tool	Description	For More Information
Solaris Dynamic Reconfiguration (DR) software	DR is used in conjunction with hot-plug operations and provides the ability to logically and physically attach or detach hardware resources (such as PCI cards) without impacting normal system operations.	See page 144.
Multipathing software	Multipathing software is used to define and control alternate (redundant) physical paths to I/O devices. If the active path to a device becomes unavailable, the software can automatically switch to an alternate path to maintain availability.	See page 148.
Sun Management Center software	Sun Management Center software is a convenient, single solution for managing multiple Sun servers, devices, and network resources. With its simple Java technology-based graphical interface, Sun Management Center lets you manage and monitor servers remotely from any location in the network. It also provides access to real-time system performance and configuration data, and helps diagnose potential capacity problems and performance bottlenecks.	See page 149.

Tool	Description	For More Information
Sun Remote System Control (RSC) software	RSC is a remote management tool for monitoring and controlling geographically distributed or physically inaccessible servers over modem lines or an Ethernet network. RSC software works in conjunction with the RSC card in the Sun Fire 880 server to serve as a “lights out” management tool that continues to function even when the server operating system goes offline, the server is powered off, or a power outage occurs.	See page 150.
Volume management software	Volume management applications, such as Solstice DiskSuite and VERITAS Volume Manager, provide easy-to-use online disk storage management for enterprise computing environments. Using advanced RAID technology, these products ensure high data availability, excellent I/O performance, and simplified administration.	See page 152.
Solaris luxadm utility	The Solaris luxadm utility is a command-line management tool for administering Sun Fire 880 internal FC-AL disk subsystems and attached external storage arrays. This utility is used to perform physical disk management tasks, including disk hot-plug operations.	See page 156.
Sun Cluster software	Sun Cluster software enables multiple Sun servers to be interconnected so that they work together as a single, highly available and scalable system. Sun Cluster software delivers high availability—through automatic fault detection and recovery—and scalability, ensuring that mission-critical applications and services are always available when needed.	See page 157.

About Hot-Pluggable and Hot-Swappable Components

Sun Fire 880 systems feature a variety of hot-pluggable and hot-swappable components. *Hot-pluggable* components are components that you can install or remove while the system is running, without affecting the rest of the system's capabilities. However, in many cases, you must prepare the operating system prior to the hot-plug event by performing certain system administration tasks. Hot-pluggable components that require no such preparation are called *hot-swappable* components. These components can be removed or inserted at any time without preparing the operating system in advance. While all hot-swappable components are hot-pluggable, not every hot-pluggable component is hot-swappable.

Sun Fire 880 hot-pluggable components fall into three basic groups:

- Fan trays and power supplies
- Disk drives
- PCI cards

Each group is discussed in more detail in the sections that follow.

Note – PCI and disk hot-plug operations are not supported when the system `ok` prompt is displayed. You can only perform these hot-plug operations while the operating system is running.



Caution – The RSC card is *not* a hot-pluggable component. Before installing or removing an RSC card, you must power off the system and disconnect all AC power cords.

Fan Trays and Power Supplies

Sun Fire 880 fan trays and power supplies are hot-swappable—they can be removed or inserted at any time without requiring prior software preparations. Keep in mind that a power supply is not considered hot-swappable unless it is part of an N+1 redundant power configuration—a system configured with the optional third power supply. Do not remove a power supply from a working system if its removal would leave the system with fewer than two working power supplies.

Unlike other hot-pluggable devices, you can install or remove a power supply or fan tray while the system is operating at the `ok` prompt. However, in the case of the power supply, you must issue a `reset -all` command at the `ok` prompt in order for the change to be recognized the next time the operating system is booted.

Note – If you remove a power supply or fan tray while the operating system is running, wait for an acknowledgement message on the system console before installing a replacement part; otherwise, the environmental monitoring software will not recognize the new device and false error conditions will result.



Caution – When hot-swapping a redundant fan tray, do not put your hand into the empty fan tray bay. The fans in the populated bay are still spinning.

For additional information, see:

- “About Power Supplies” on page 73
- “About Fan Trays” on page 75

Disk Drives

Sun Fire 880 internal disk drives are hot-pluggable. However, certain software preparations are required. To perform Sun Fire 880 disk drive hot-plug operations, you use the Solaris `luxadm` utility. The `luxadm` utility is a command-line tool for managing intelligent storage arrays such as Sun StorEdge A5x00 series disk arrays or Sun Fire 880 internal storage arrays. For more information on `luxadm`, see “About the Solaris `luxadm` Utility” on page 156. For complete disk hot-plug procedures, refer to *Platform Notes: Using luxadm Software*, available on the *Solaris on Sun Hardware AnswerBook*. This AnswerBook documentation is provided on the Sun Computer Systems Supplement CD for your specific Solaris release.



Caution – When hot-plugging a disk drive, after disconnecting the drive from its backplane, allow 30 seconds or so for the drive to spin down completely before removing it from its drive bay.

PCI Cards

On Sun Fire 880 systems, PCI cards are hot-pluggable, while the Remote System Control (RSC) card is *not* hot-pluggable.

Hot-plug operations for PCI cards involve Dynamic Reconfiguration (DR). DR is an operating environment feature that provides the ability to reconfigure system hardware while the system is running. DR lets you logically attach or detach hardware resources within an active operating environment. The main benefit of DR is that a service provider can add or replace hardware resources with little or no impact on normal system operations.

PCI hot-plug procedures may involve software commands for preparing the system prior to removing a device, and for reconfiguring the operating environment after installing a new device. In addition, certain system requirements must be met in order for hot-plug operations to succeed.

For information about system requirements and limitations, and for detailed PCI hot-plug procedures, refer to the *Sun Fire 880 Dynamic Reconfiguration User's Guide*, which is available on the *Solaris on Sun Hardware AnswerBook*. This AnswerBook documentation is provided on the Sun Computer Systems Supplement CD for your specific Solaris release.



Caution – You can hot-plug any standard PCI card that complies with PCI Hot-Plug Specification Revision 1.1, provided a suitable software driver exists for the Solaris operating environment, and the driver supports hot-plugging as described in the *Sun Fire 880 Dynamic Reconfiguration User's Guide*. The Sun Fire 880 system must be running the Solaris 8 7/01 operating environment or a subsequent release that supports Sun Fire 880 PCI hot-plug operations. Do not attempt to hot-plug a PCI card until you are certain that its device drivers provide the proper support; otherwise, you may cause a system panic. For a list of Sun PCI cards and device drivers that support PCI hot-plug operations, see the *Sun Fire 880 Server Product Notes*.

Note – DR works in conjunction with (but does not require) multipathing software. You can use multipathing software to switch I/O operations from one I/O controller to another to prepare for DR operations. With a combination of DR and multipathing software, you can remove, replace, or deactivate a PCI controller card with little or no interruption to system operation. Note that this requires redundant hardware; that is, the system must contain an alternate I/O controller that is connected to the same device(s) as the card being removed or replaced. The alternate controller must reside on a different PCI card or be integrated into the Sun Fire 880 system motherboard or I/O board. For additional details, see “About Multipathing Software” on page 148.

PCI Hot-Plug User Interfaces

There are two different methods for performing PCI hot-plug operations on Sun Fire 880 systems:

- Push-button method
- Command-line method

The push-button method relies on push buttons and status LEDs located near each PCI slot. You can initiate a PCI hot-plug operation by pressing the push button for the corresponding slot. The command-line method lets you initiate PCI hot-plug operations via a remote login session, an RSC console, or a locally attached console. This method involves the Solaris `cfgadm(1)` command.

Both hot-plug methods make use of the status LEDs located near each PCI slot. These LEDs indicate where and when it is safe to insert or remove a board, and also show whether the operation has succeeded or failed. For additional details on hot-plug status LEDs, see “About PCI Slot LEDs” on page 161.

Note – Regardless of the method you use, it is often necessary to perform additional administrative steps to prepare for a PCI hot-plug removal operation. Prior to performing a removal operation, you must ensure that the devices residing on the card are not currently in use. To identify and manually terminate usage of such devices, you can use standard Solaris operating environment commands such as `mount(1M)`, `umount(1M)`, `swap(1M)`, `ifconfig(1M)`, and `ps(1)`.

For detailed PCI hot-plug procedures, refer to the *Sun Fire 880 Dynamic Reconfiguration User's Guide*, available on the *Solaris on Sun Hardware AnswerBook*. This AnswerBook documentation is provided on the Sun Computer Systems Supplement CD for your specific Solaris release.

About Multipathing Software

Multipathing software lets you define and control redundant physical paths to I/O devices such as storage devices and networks. If the active path to a device becomes unavailable, the software can automatically switch to an alternate path to maintain availability. This capability is known as *automatic failover*. To take advantage of multipathing capabilities, your server must be configured with redundant hardware, such as redundant network interfaces or two FC-AL host bus adapters connected to the same dual-ported storage array.

Multipathing software is often used in conjunction with Solaris Dynamic Reconfiguration (DR) software (see “About Hot-Pluggable and Hot-Swappable Components” on page 144). In response to a component failure in an active path, the multipathing software automatically switches to an alternate path, while the DR feature lets you remove and replace the faulty component without impacting normal system operations.

For Sun Fire 880 systems, two different types of multipathing software are available:

- Solaris IP Network Multipathing provides multipathing and load balancing capabilities for IP network interfaces.
- VERITAS Volume Manager includes a feature called Dynamic Multipathing (DMP), which provides disk multipathing as well as disk load balancing to optimize I/O throughput.

For More Information

For information about setting up redundant hardware interfaces for storage devices or networks, see:

- “About Sun Fire 880 Mass Storage Features” on page 92
- “About Redundant Network Interfaces” on page 105

For instructions on how to configure and administer Solaris IP Network Multipathing, consult the *IP Network Multipathing Administration Guide* provided with your specific Solaris release.

For information about VERITAS Volume Manager and its DMP feature, see “About Volume Management Software” on page 152 and refer to the documentation provided with the VERITAS Volume Manager software.

About Sun Management Center Software

Sun Management Center software provides a single solution for managing multiple Sun systems, devices, and network resources. With its intuitive Java technology-based graphical interface, Sun Management Center offers powerful management capabilities that let you:

- Manage and monitor your server remotely from any location in the network
- Display physical and logical views of your exact server configuration
- Monitor system health conditions
- Access real-time system performance and configuration data to diagnose potential capacity problems and performance bottlenecks
- Invoke SunVTS diagnostic software for online diagnosis of hardware problems
- Use predictive failure analysis features to warn of potential memory and disk hardware failures before they happen
- Organize systems by geographical location, server function, administrative responsibility, or other criteria for increased management flexibility
- Implement enterprise-wide security measures, such as authentication, data integrity, and access control lists

For More Information

Sun Management Center software is provided on a CD supplied in the Solaris media kit for your release. For information about installing and using Sun Management Center software, see the following documents provided with the Sun Management Center software:

- *Sun Management Center Software Installation Guide*
- *Sun Management Center Software User's Guide*
- *Sun Management Center Software Supplement for Workgroup Servers*

About Sun Remote System Control Software

Sun Remote System Control (RSC) software is a remote server management tool that lets you monitor and control supported Sun servers over modem lines or over a network. RSC provides remote system administration for geographically distributed or physically inaccessible systems and complements existing Sun monitoring and diagnostics tools such as Sun Management Center, SunVTS, OpenBoot PROM, and OpenBoot Diagnostics.

RSC software works with the RSC card included in all Sun Fire 880 servers. The RSC card runs independently of the host server, and operates off of 5-volt standby power from the system's power supplies. The card also includes a battery that provides approximately 30 minutes of back-up power in the event of a power failure. Together these features allow RSC to serve as a "lights-out" management tool that continues to function even when the server operating system goes offline, the system is powered off, or a power outage occurs.

The RSC card plugs into a dedicated slot on the system I/O board and provides the following ports through an opening in the system rear panel:

- 10-Mbps Ethernet port via an RJ-45 twisted-pair Ethernet (TPE) connector
- 56-Kbps modem port via an RJ-11 connector
- EIA-232D serial port via an RJ-45 connector

RSC Capabilities

Using RSC software, you can:

- Access Solaris and OpenBoot PROM console functions remotely via the modem, serial, and Ethernet ports on the RSC card
- Run power-on self-test (POST) and OpenBoot Diagnostics from a remote console
- Remotely monitor server environmental conditions, such as fan, temperature, and power supply status, even when the server is offline
- View a graphical representation of the server's front panel, including keyswitch position and LED states
- Receive notification of server problems via email or pager, even in the event of a power failure
- Perform remote server reboot, power-on, and power-off functions on demand
- Access a detailed log of RSC events, command history, and detected errors

RSC User Interfaces

RSC offers the following user interfaces:

- A graphical user interface (GUI) that runs as a Java client application on workstations connected to the server through the RSC Ethernet interface or through a standard modem connection using Point-to-Point Protocol (PPP)
- A command-line interface (CLI) that you can access through the RSC Ethernet network, through a standard modem connection, or through an alphanumeric terminal attached directly to the RSC serial port.

The Java technology-based GUI client application runs on workstations running the Solaris, Microsoft Windows 95, Windows 98, or Windows NT operating environments.

For More Information

Sun RSC software is included on the Computer Systems Supplement CD for your specific Solaris release. For installation instructions, see the *Solaris Sun Hardware Platform Guide* provided in the Solaris media kit. For information about configuring and using RSC, see the *Sun Remote System Control (RSC) User's Guide* provided with the RSC software.

About Volume Management Software

Sun Microsystems offers two different volume management applications for use on Sun Fire 880 systems:

- VERITAS Volume Manager software
- Solstice DiskSuite software

Volume management software lets you create disk volumes. Volumes are logical disk devices comprising one or more physical disks or partitions from several different disks. Once a volume is created, the operating system uses and maintains the volume as if it were a single disk. By providing this logical volume management layer, the software overcomes the restrictions imposed by physical disk devices.

Sun's volume management products also provide RAID data redundancy and performance features. RAID, which stands for *redundant array of independent disks*, is a technology that helps protect against disk and hardware failures. Through RAID technology, volume management software is able to provide high data availability, excellent I/O performance, and simplified administration.

Sun's volume management applications offer the following features:

- Support for several types of RAID configurations, which provide varying degrees of availability, capacity, and performance
- Hot-spare facilities, which provide for automatic data recovery when disks fail
- Performance analysis tools that let you monitor I/O performance and isolate bottlenecks
- A graphical user interface that simplifies storage management
- Support for online resizing, which enables volumes and their file systems to grow and shrink online
- Online reconfiguration facilities, which let you change to a different RAID configuration or modify characteristics of an existing configuration

VERITAS Dynamic Multipathing

VERITAS Volume Manager software actively supports multiported disk arrays. It automatically recognizes multiple I/O paths to a particular disk device within an array. Called Dynamic Multipathing (DMP), this capability provides increased reliability by providing a path failover mechanism. If one connection to a disk is lost, VERITAS Volume Manager continues to access the data over the remaining

connections. This multipathing capability also provides greater I/O throughput by automatically balancing the I/O load uniformly across multiple I/O paths to each disk device.

RAID Concepts

VERITAS Volume Manager and Solstice DiskSuite software support RAID technology to optimize performance, availability, and user cost. RAID technology improves performance, reduces recovery time in the event of file system errors, and increases data availability even in the event of a disk failure. There are several levels of RAID configurations that provide varying degrees of data availability with corresponding trade-offs in performance and cost.

This section describes some of the most popular and useful of those configurations, including:

- Disk concatenation
- Disk mirroring (RAID 1)
- Disk striping (RAID 0)
- Disk striping with parity (RAID 5)
- Hot spares

Disk Concatenation

Disk concatenation is a method for increasing logical volume size beyond the capacity of one disk drive by creating one large volume from two or more smaller drives. This lets you create arbitrarily large partitions.

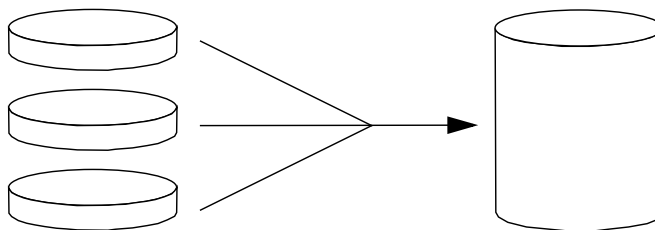

Using this method, the concatenated disks are filled with data sequentially, with the second disk being written to when no space remains on the first, the third when no room remains on the second, and so on.

RAID 1: Disk Mirroring

Disk mirroring (RAID 1) is a technique that uses data redundancy—two complete copies of all data stored on two separate disks—to protect against loss of data due to disk failure. One logical volume is duplicated on two separate disks.

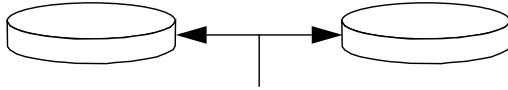

Whenever the operating system needs to write to a mirrored volume, both disks are updated. The disks are maintained at all times with exactly the same information. When the operating system needs to read from the mirrored volume, it reads from whichever disk is more readily accessible at the moment, which can result in enhanced performance for read operations.

RAID 1 offers the highest level of data protection, but storage costs are high, and write performance is reduced since all data must be stored twice.

RAID 0: Disk Striping

Disk striping (RAID 0) is a technique for increasing system throughput by using several disk drives in parallel. Whereas in non-striped disks the operating system writes a single block to a single disk, in a striped arrangement, each block is divided and portions of the data are written to different disks simultaneously.

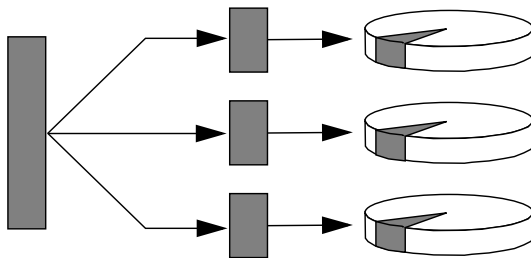

System performance using RAID 0 will be better than using RAID 1 or 5, but the possibility of data loss is greater because there is no way to retrieve or reconstruct data stored on a failed disk drive.

RAID 5: Disk Striping With Parity

RAID 5 is an implementation of disk striping in which parity information is included with each disk write. The advantage of this technique is that if any one disk in a RAID 5 array fails, all the information on the failed drive can be reconstructed from the data and parity on the remaining disks.

System performance using RAID 5 will fall between that of RAID 0 and RAID 1; however, RAID 5 provides limited data redundancy. If more than one disk fails, all data is lost.

Hot Spares (Hot Relocation)

In a “hot spares” arrangement, one or more disk drives are installed in the system but are unused during normal operation. Should one of the active drives fail, the data on the failed disk is automatically reconstructed and generated on a hot spare disk, enabling the entire data set to maintain its availability.

For More Information

See the documentation supplied with the VERITAS Volume Manager and Solstice DiskSuite software.

About the Solaris luxadm Utility

The luxadm program is a command-line management utility for administering the Sun Fire 880 internal Fibre Channel-Arbitrated Loop (FC-AL) storage subsystem and supported external storage arrays. You use luxadm to perform physical disk management tasks, including disk hot-plug operations. The luxadm utility is installed automatically when you install the Solaris operating environment.

The luxadm utility performs a variety of control and query tasks through a number of subcommands and command-line options. Using luxadm, you can:

- Assign a convenient enclosure name to the Sun Fire 880 internal storage array
- Display the physical and logical device paths, world wide names (WWNs), and enclosure names for storage arrays and individual disks
- Display configuration, environmental, and status information for any array or individual disk
- Reserve a specific disk for exclusive use by a single host
- Perform hot-plug insertion or removal of disks
- Download firmware and fcode updates for mass storage components

Note – Setting the front panel keyswitch to the Locked position prevents reprogramming of system firmware. If the keyswitch is turned to the Locked position after firmware update operation has started, the operation is allowed to proceed to completion. For more information about the front panel keyswitch, see “About the Status and Control Panel” on page 10.

For More Information

Platform Notes: Using luxadm Software provides information about the luxadm utility, including descriptions of hot-plug procedures for Sun Fire 880 internal disk drives. This document is available on the *Solaris on Sun Hardware AnswerBook*, provided on the Sun Computer Systems Supplement CD for your specific Solaris release.

Refer also to the luxadm(1M) man page.

About Sun Cluster Software

Sun Cluster software lets you connect multiple Sun servers in a cluster configuration. A *cluster* is a group of nodes that are interconnected to work as a single, highly available and scalable system. A *node* is a single instance of Solaris software—it may be running on a standalone server or on a domain within a standalone server. With Sun Cluster software, you can add or remove nodes while online, and mix and match servers to meet your specific needs.

Sun Cluster software delivers high availability through automatic fault detection and recovery, and scalability, ensuring that mission-critical applications and services are always available when needed.

With Sun Cluster software installed, other nodes in the cluster will automatically take over and assume the workload when a node goes down. It delivers predictability and fast recovery capabilities through features such as local application restart, individual application failover, and local network adapter failover. Sun Cluster software significantly reduces downtime and increases productivity by helping ensure continuous service to all users.

The software lets you run both standard and parallel applications on the same cluster. It supports the dynamic addition or removal of nodes, and enables Sun servers and storage products to be clustered together in a variety of configurations. Existing resources are used more efficiently, resulting in additional cost savings.

Sun Cluster software allows nodes to be separated by up to 10 kilometers. This way, in the event of a disaster in one location, all mission-critical data and services remain available from the other unaffected locations.

For More Information

See the documentation supplied with the Sun Cluster software.

LED Status Indicators

This chapter provides information about the system's interior and rear panel LED status indicators. Topics covered in this chapter include:

- "About CPU/Memory Slot LEDs" on page 160
- "About PCI Slot LEDs" on page 161
- "About Power Supply LEDs" on page 163
- "About Fan Tray LEDs" on page 164
- "About Disk Drive LEDs" on page 166
- "About the Gigabit Ethernet LEDs" on page 168

For a description of the system's front panel LED indicators, see "About the Status and Control Panel" on page 10.

About CPU/Memory Slot LEDs

The CPU/Memory slot LEDs are located on the horizontal panel between CPU/Memory slots B and C and are visible when the right side door is open. There are three LEDs for each CPU/Memory slot, as shown below.



Icon	Name	LED Function
	Power On	Lights when the slot is receiving power.
	Fault	Reserved for future use.
	OK-to-Remove	Reserved for future use.

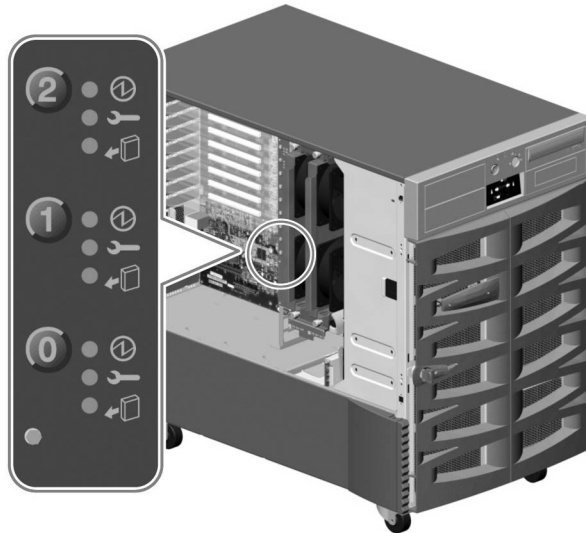

About PCI Slot LEDs

The PCI slot LEDs are located on the vertical bracket on the right side of the PCI slots and are visible when the left side door is open. There are three LEDs for each PCI slot, as shown below.



Icon	Name	LED Function
	Power On	Lights when the slot is receiving power.
	Fault	Blinks while the card is being tested, when a hot-plug operation is in progress, or when the card is powered on but logically detached from the operating system. Stays lit if the card encounters a fault.
	OK-to-Remove	Lights when it is safe to remove the card.

The following table shows how to interpret the various possible LED patterns.

			Interpretation
Off	Off	Off	The slot power is off. A PCI card can be safely inserted to start a hot-plug operation.
On	Blinking	Off	The installed card is being tested, configured, or unconfigured, or the card is powered on but logically detached from the operating system.
On	Off	Off	The slot power is on and the PCI card is operating normally.
Off	On	On	The PCI card has encountered a fault. The card can be safely removed.
Off	Off	On	The card can be safely removed.

Note – If the slot is empty and the Fault or OK-to-Remove LED is on, pressing the contact push button for the slot will clear the LED.



For more information about PCI cards and hot-plug operations, see:

- “About PCI Cards and Buses” on page 68
- “About Hot-Pluggable and Hot-Swappable Components” on page 144

About Power Supply LEDs

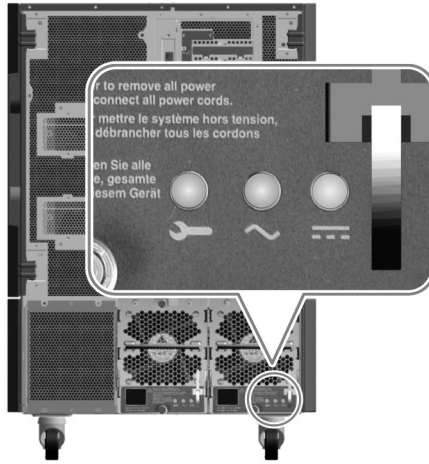
There are three LEDs located on the rear of each power supply, as shown below.



Icon	Name	LED Function
	Fault	Lights when the power supply encounters a fault.
	AC-Present Status	Lights when AC power input is present and within acceptable operating limits.
	DC Status	Lights when all DC outputs are functional and within acceptable operating limits.

About Fan Tray LEDs



The Thermal Fault LED on the system status and control panel indicates the overall status of the cooling system. The Thermal Fault LED lights when a fan fault or overtemperature condition is detected. LEDs inside the system indicate the fault status of each fan tray assembly.

The fan tray LEDs are located beside or beneath each fan tray assembly. There are three LEDs (Power On, Fault, and OK-to-Remove) per fan tray, as shown below.



Icon	Name	LED Function
	Power On	Lights when the fan tray is receiving power.
	Fault	Lights when the fan tray encounters a fault.
	OK-to-Remove	Lights when it is safe to remove the fan tray assembly from a powered-on system (only when redundant fan trays are present).

The following table shows how to interpret the various possible LED patterns.

			Interpretation
Off	Off	Off	The fan tray is not receiving power or is improperly inserted.
On	Off	Off	The fan tray is receiving power and operating normally.
Off	On	On	The fan tray has encountered a fault and can be safely removed from a powered-on system.

For more information about fan trays and hot-plug operations, see:



- “About Fan Trays” on page 75
- “About Hot-Pluggable and Hot-Swappable Components” on page 144

About Disk Drive LEDs

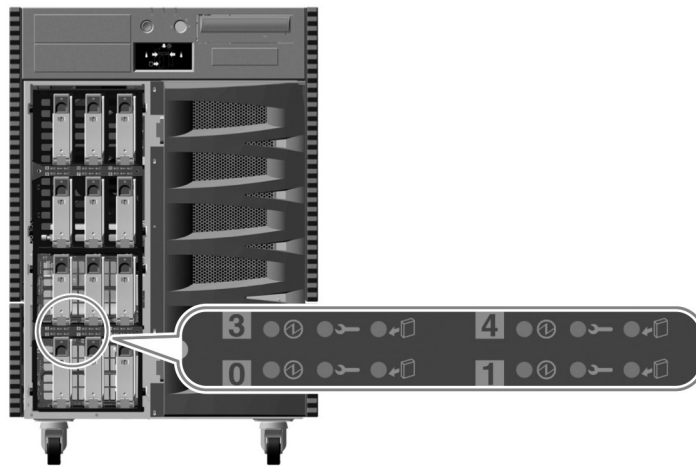

The Disk Fault LED on the system status and control panel indicates the general status of the disk subsystem. The Disk Fault LED lights when a fault is detected in the disk subsystem. LEDs inside the system indicate the fault status of individual disk drives.

There are three LEDs (Activity, Fault, OK-to-Remove) for each disk drive. The disk drive LEDs are located on the front of the disk cage, as shown below.



Icon	Name	LED Function
	Activity	<p>Blinks slowly while the disk drive is being tested, configured, or unconfigured during a hot-plug operation.</p> <p>Blinks rapidly as the disk drive spins up or spins down.</p> <p>Stays lit when the disk drive is at speed and operating normally but experiencing no read or write activity. Blinks rapidly and irregularly in response to disk read or write activity.</p>
	Fault	Lights when the disk drive encounters a fault.
	OK-to-Remove	<p>Lights when it is safe to remove the disk drive during a hot-plug operation.</p> <p>Blinks (under software control) to direct attention to a disk drive.</p>

The following table shows how to interpret the various possible LED patterns.

			Interpretation
Off	Off	Off	Slot power is off. A disk drive can be safely inserted as part of a hot-plug operation.
Rapid Blinking	Off	Off	Disk drive is spinning up or down.
Slow Blinking	Off	Off	Disk drive is being configured or unconfigured during a hot-plug operation.
On	Off	Off	Disk drive is up to speed and operating normally.
Irregular Blinking	Off	Off	Disk drive is experiencing read or write activity.
On	On	Off	Disk drive has encountered a fault.
Off	Off	On	Disk drive can be safely removed as part of a hot-plug operation.

For more information about disk drives and hot-plug operations, see:

- “About Internal Disk Drives” on page 97
- “About Hot-Pluggable and Hot-Swappable Components” on page 144

About the Gigabit Ethernet LEDs

Four LEDs provide status information for the Gigabit Ethernet port. The LEDs are located above the Gigabit Ethernet port on the system rear panel, as shown below.

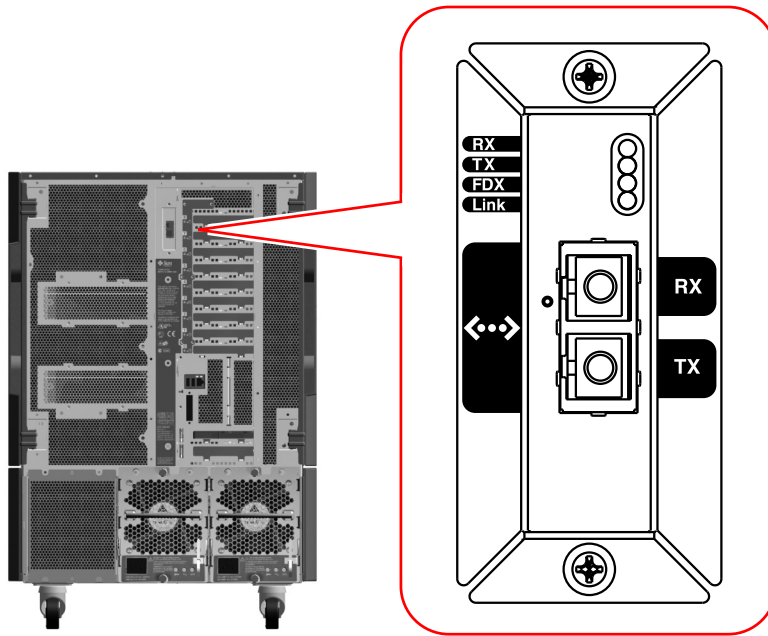

Label	Name	LED Function
RX	Receive Activity	Indicates data activity on the receive channel.
TX	Transmit Activity	Indicates data activity on the transmit channel.
FDX	Full Duplex	Indicates that the Gigabit Ethernet interface is operating in Full Duplex mode.
Link	Link Present	Indicates that a link is established with a link partner.

Using Removable Media Storage Devices

The Sun Fire 880 system provides three mounting bays for 5.25-inch half-height (1.6-inch) devices. One of the bays houses a digital versatile disc-read only memory (DVD-ROM) drive, which comes standard in all system configurations. The other two bays can be used for wide (68-pin) or narrow (50-pin) SCSI tape drives, such as 8-mm tape drives or 4-mm DDS-2 or DDS-3 tape drives. Narrow SCSI devices require a 68-pin to 50-pin SCSI adapter (Sun part number X913A), which must be ordered separately. You can easily convert the two bays into a single full-height bay by removing a metal shelf divider.

This chapter contains basic information about how to use removable media storage devices.

The following tasks are covered in this chapter:

- “How to Insert a CD or DVD Into the Drive” on page 171
- “How to Eject a CD or DVD With Software Commands” on page 173
- “How to Eject a CD or DVD Manually” on page 175
- “How to Eject a CD or DVD in an Emergency” on page 177
- “How to Clean a CD or DVD” on page 179
- “How to Insert a Tape Cartridge” on page 182
- “How to Remove a Tape Cartridge” on page 183
- “How to Control a Tape Drive” on page 184
- “How to Clean a Tape Drive” on page 185

Other information covered in this chapter includes:

- “About the DVD-ROM Drive” on page 170
- “About Tape Drives and Tape Cartridges” on page 181

About the DVD-ROM Drive

The digital versatile disc-read only memory (DVD-ROM) drive in your system ships with a specification sheet that contains the following information:

- Type of DVD-ROM discs that you can use with the drive
- Handling and storage information
- Physical characteristics
- Power requirements
- Cleaning instructions
- Description of DVD-ROM drive controls, indicators, and jumper settings

How to Insert a CD or DVD Into the Drive

What to Do

1. Push the Eject button on the DVD-ROM drive to release the drive tray.
2. Place a CD or DVD into the drive tray, label side up.

A disc is a single- or double-sided storage medium. Place it into the tray with the appropriate label side up, as shown.

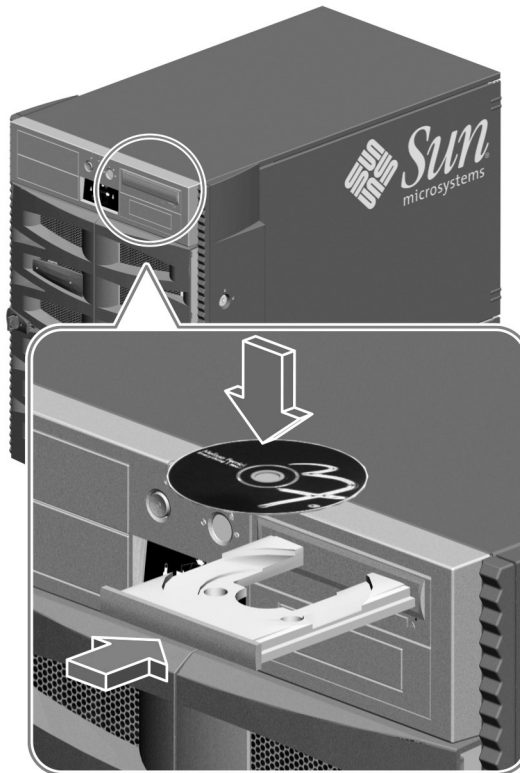

3. Gently push the tray back into the drive.
The drive has an automated closing mechanism that retracts the tray into the drive.

What Next

You can eject a CD or DVD from the drive by using one of three methods:

- With software commands; see “How to Eject a CD or DVD With Software Commands” on page 173
- Manually; see “How to Eject a CD or DVD Manually” on page 175
- Using an emergency procedure; see “How to Eject a CD or DVD in an Emergency” on page 177

How to Eject a CD or DVD With Software Commands

Before You Begin

If the server is set up without a system console, you need to set up one in order to issue software commands; see:

- “About Setting Up a Console” on page 45

What to Do

1. From the system console device, change directories to a directory that is not in the /cdrom hierarchy.
2. Type the following command to eject the CD or DVD:

```
% eject cdrom
```

The disc should eject.

3. If the disc does not eject, kill any processes accessing the DVD-ROM drive and repeat step 2.

The disc will not eject while the drive is in use. To kill any processes accessing the DVD-ROM drive, become superuser and type the following:

```
% su
Password:
# fuser -k /cdrom/cdrom0
```

Note – You should warn users before abruptly halting processes. The command `fuser -u /cdrom/cdrom0` helps identify who is accessing the DVD-ROM drive. Refer to the *Solaris System Administrator's Guide* for more information about the `fuser` command.

What Next

You can also eject a disc by using one of these methods:

- Manually; see “How to Eject a CD or DVD Manually” on page 175
- Using an emergency procedure; see “How to Eject a CD or DVD in an Emergency” on page 177

How to Eject a CD or DVD Manually

Before You Begin

If the server is set up without a system console, you need to set up one in order to issue software commands; see:

- “About Setting Up a Console” on page 45

What to Do

1. **From the console device, change directories to a directory that is not in the `/cdrom` hierarchy.**
2. **Press the Eject button on the front panel.**

The drive should eject the tray so that you can remove the disc.



3. If the disc does not eject, kill any processes accessing the DVD-ROM drive and repeat step 2.

The disc will not eject while the drive is in use. To kill any processes accessing the DVD-ROM drive, become superuser and type the following:

```
% su
Password:
# fuser -k /cdrom/cdrom0
```

Note – You should warn users before abruptly halting processes. The command `fuser -u /cdrom/cdrom0` helps identify who is accessing the DVD-ROM drive. Refer to the *Solaris System Administrator's Guide* for more information about the `fuser` command.

What Next

You can also eject a disc by using one of these methods:

- With software commands; see “How to Eject a CD or DVD With Software Commands” on page 173
- Using an emergency procedure; see “How to Eject a CD or DVD in an Emergency” on page 177

How to Eject a CD or DVD in an Emergency

Before You Begin

Use the emergency ejection procedure *only in emergency situations*; for instance, if you unmount the disc and the Eject button does not function.

What to Do



Caution – If this procedure is used while a disc is mounted, you can degrade or destroy data in your system.

1. **Turn off the power to your system.**
See “How to Power Off the System” on page 53.
2. **Unfold and straighten one end of a large wire paper clip.**

3. Insert the straightened end of the clip into the emergency eject hole and press firmly.
4. Pull the tray from the drive after the clip is inserted into the hole.



What Next

You can also eject a disc by using one of these methods:

- With software commands; see “How to Eject a CD or DVD With Software Commands” on page 173
- Manually; see “How to Eject a CD or DVD Manually” on page 175

How to Clean a CD or DVD

Before You Begin

Eject the CD or DVD and remove it from the tray; see:

- “How to Eject a CD or DVD With Software Commands” on page 173

Note – If the drive cannot read a disc, you may have a dusty or dirty disc.

What to Do

1. Clean the disc with compressed air.

Compressed air can remove most accumulations of dust and large dirt particles. If you have access to the drive’s read head, verify that it is also dust free.

2. If spraying with compressed air fails to remove the dirt on a disc, wipe the disc using a soft, clean, lint-free, *dry* cloth.

- Wipe the data areas of the disc (on both sides if necessary) *radially* from the center to the outside.
- Do *not* wipe in a circular motion.
- Wipe only the affected areas of the disc.

The figure below shows the correct and incorrect way to clean a CD or DVD.

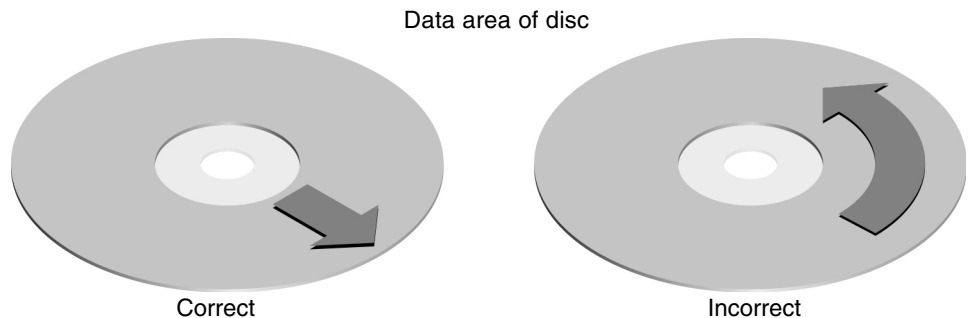

What Next

To insert a CD or DVD into the drive, see:

- “How to Insert a CD or DVD Into the Drive” on page 171.

About Tape Drives and Tape Cartridges

There are a number of different tape drives offered by Sun Microsystems for your system. Each tape drive is shipped with a specification sheet that contains the following information:

- Type of cartridges that can be used with the drive
- Cartridge storage capacity
- Handling and storage information
- Physical characteristics
- Power requirements
- Cleaning instructions
- Description of controls, indicators, and jumper settings

Handling and Storing Tape Cartridges

The following general handling and storage information applies to cartridges for any of the tape drives offered for your system:

- Keep cartridges away from anything magnetic.
- Store cartridges in a dust-free environment.
- Keep cartridges away from direct sunlight and sources of heat, cold, or humidity. Constant room temperature and 50 percent humidity is recommended.
- Do not touch the surface of the tape.

Thermal Conditioning

To ensure proper thermal conditioning, keep the tape cartridge at the same temperature as the drive for 24 hours. This applies to cartridges for any of the tape drives offered for your system.

How to Insert a Tape Cartridge

What to Do

1. **Verify that the tape cartridge write-protect switch is set correctly.**
If the lock window is open, the tape is write-protected.

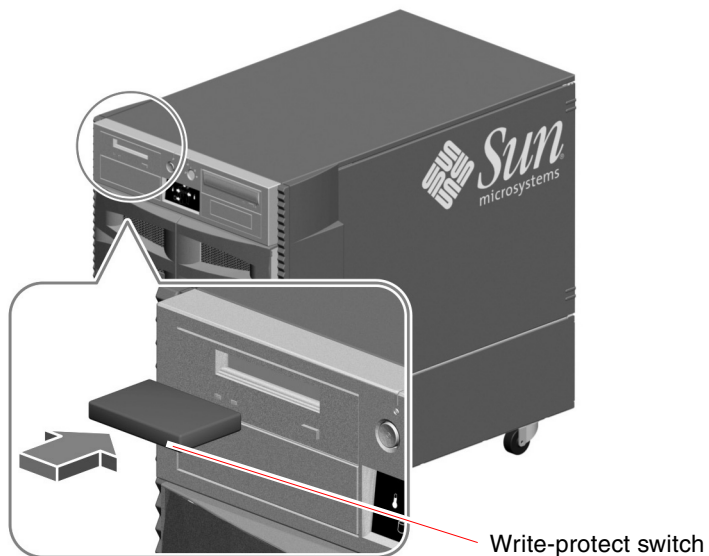

2. **Insert the cartridge into the drive, label side up.**
3. **Push gently on the cartridge until it is pulled into the drive.**

What Next

To remove a tape cartridge from the drive, see:

- "How to Remove a Tape Cartridge" on page 183

How to Remove a Tape Cartridge

Before You Begin

Note – The information in this section applies to a DDS-3 tape drive. If you have a different type of tape drive installed, see the specifications shipped with the drive for information.

What to Do

1. Check that there is no drive activity.

The green activity LED should be unlit. A flashing LED indicates drive activity.



Caution – Do not eject the tape cartridge when the drive is active, or you may incur data loss or equipment damage.

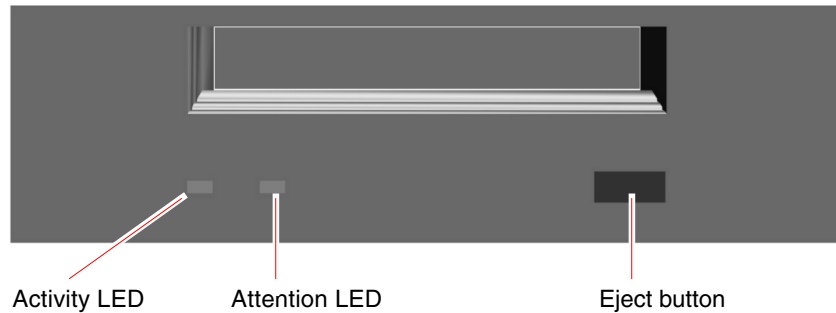

2. Push the Eject button and remove the tape cartridge.

What Next

To insert a tape cartridge into the drive, see:

- “How to Insert a Tape Cartridge” on page 182

How to Control a Tape Drive

What to Do

For information about software commands needed to read and write data with your tape drive, refer to the *Solaris Handbook for Sun Peripherals* or the *Solaris User's Guide*.

How to Clean a Tape Drive

Before You Begin

Observe these rules about *when* to clean a tape drive:

1. Clean the drive after the first four hours of use with a new tape.
2. After that, clean the tape drive after every 25 hours of use to maintain reliable operation.
3. Clean the drive twice as often if you use it in a dusty environment or operate it infrequently.

What to Do

- **Insert a cleaning cartridge into the drive.**

The tape should play for a short while, and then eject automatically.

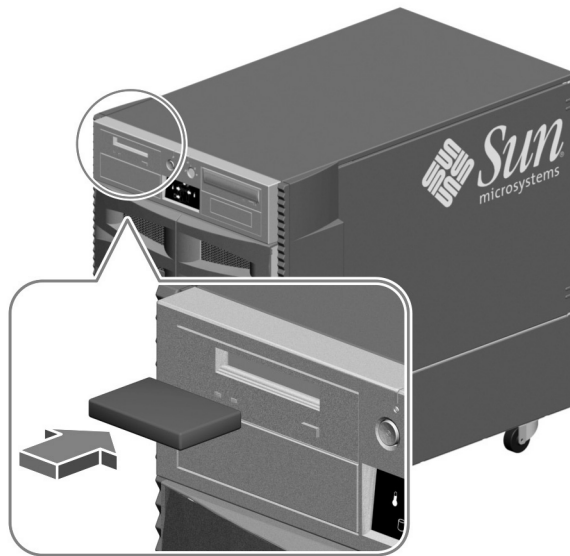

Do not use any cartridge other than a DDS-approved cleaning tape cartridge to clean your tape drive.

Connector Pinouts

This appendix gives you reference information about the system's rear panel ports and pin assignments. Topics covered in this appendix include:

- "Reference for Serial Port A and B Connectors" on page 188
- "Reference for the USB Connectors" on page 189
- "Reference for the Twisted-Pair Ethernet Connector" on page 190
- "Reference for the RSC Ethernet Connector" on page 191
- "Reference for the RSC Modem Connector" on page 192
- "Reference for the RSC Serial Connector" on page 193

Reference for Serial Port A and B Connectors

Serial Port Connector Diagram

The serial port conforms to EIA-423 and EIA-232D specifications.

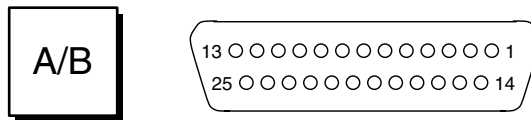

Serial Port Signals

Signal descriptions ending in “A” indicate that the signal is associated with the port provided by a standard DB-25 serial cable or the connector labeled “A” on the optional DB-25 splitter cable. Signal descriptions ending in “B” indicate the signal is associated with the port provided by the connector labeled “B” on the optional DB-25 splitter cable.

Pin	Signal Description	Pin	Signal Description
1	No Connection	14	Transmit Data B
2	Transmit Data A	15	Transmit Clock A (External)
3	Receive Data A	16	Receive Data B
4	Ready To Send A	17	Receive Clock A
5	Clear To Send A	18	Receive Clock B
6	Synchronous A	19	Ready To Send B
7	Signal Ground A	20	Data Terminal Ready A
8	Data Carrier Detect A	21	No Connection
9	No Connection	22	No Connection
10	No Connection	23	No Connection
11	Data Terminal Ready B	24	Transmit Clock A (Internal)
12	Data Carrier Detect B	25	Transmit Clock B
13	Clear To Send B		

Reference for the USB Connectors

Two Universal Serial Bus (USB) connectors are located on the system I/O board and can be accessed from the rear panel.

USB Connector Diagram

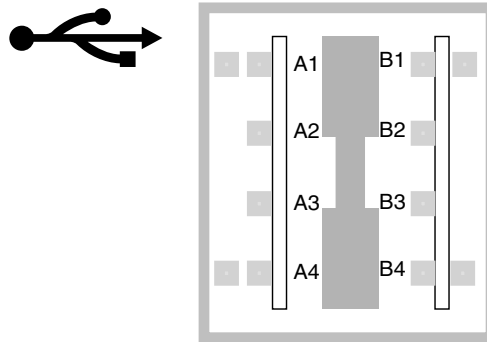

USB Connector Signals

Pin	Signal Description	Pin	Signal Description
A1	+5 VDC	B1	+5 VDC
A2	Port Data_N	B2	Port Data_N
A3	Port Data_P	B3	Port Data_P
A4	Ground	B4	Ground

Reference for the Twisted-Pair Ethernet Connector

The twisted-pair Ethernet (TPE) connector is an RJ-45 connector located on the system I/O board and can be accessed from the rear panel.

TPE Connector Diagram

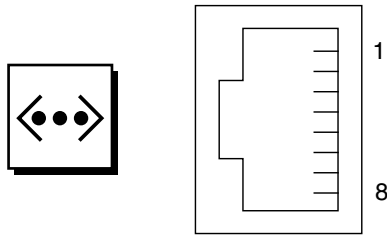

TPE Connector Signals

Pin	Signal Description	Pin	Signal Description
1	Transmit Data +	5	Common Mode Termination
2	Transmit Data -	6	Receive Data -
3	Receive Data +	7	Common Mode Termination
4	Common Mode Termination	8	Common Mode Termination

Reference for the RSC Ethernet Connector

The Remote System Control (RSC) Ethernet connector is an RJ-45 connector located on the RSC board and can be accessed from the rear panel.

RSC Ethernet Connector Diagram

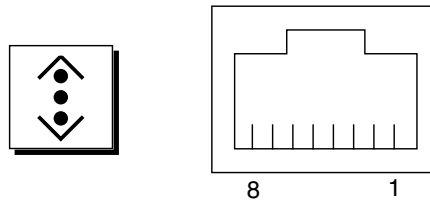

RSC Ethernet Connector Signals

Pin	Signal Description	Pin	Signal Description
1	Transmit Data +	5	Common Mode Termination
2	Transmit Data -	6	Receive Data -
3	Receive Data +	7	Common Mode Termination
4	Common Mode Termination	8	Common Mode Termination

Reference for the RSC Modem Connector

The Remote System Control (RSC) modem connector is an RJ-11 connector located on the RSC card and can be accessed from the rear panel.

RSC Modem Connector Diagram

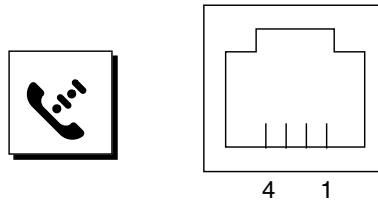

RSC Modem Connector Signals

Pin	Signal Description	Pin	Signal Description
1	No Connection	3	Tip
2	Ring	4	No Connection

Reference for the RSC Serial Connector

The Remote System Control (RSC) serial connector is an RJ-45 connector located on the RSC card and can be accessed from the rear panel.

RSC Serial Connector Diagram

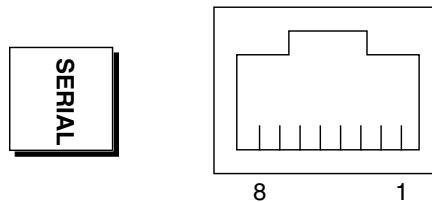

RSC Serial Connector Signals

Pin	Signal Description	Pin	Signal Description
1	Ready To Send	5	Ground
2	Data Terminal Ready	6	Receive Data
3	Transmit Data	7	No Connection
4	Ground	8	Clear To Send

System Specifications

This appendix provides the following specifications for the Sun Fire 880 server:

- “Reference for Physical Specifications” on page 196
- “Reference for Electrical Specifications” on page 196
- “Reference for Environmental Requirements” on page 197
- “Reference for Agency Compliance Specifications” on page 198
- “Reference for Clearance and Service Access Specifications” on page 198

Reference for Physical Specifications

The dimensions and weight of the system are as follows.

Measurement	U.S	Metric	Comments
Height (with casters)	28.1 in	71.4 cm	
Width	18.9 in	48.0 cm	
Depth	32.9 in	83.6 cm	
Weight:			
Minimum	194.0 lb	88.0 kg	Actual weight depends upon the installed options
Maximum	288.0 lb	130.6 kg	
Power Cord	8.2 ft	2.5 m	

Reference for Electrical Specifications

The following table provides the electrical specifications for the system.

Parameter	Value
Input	
Nominal Frequencies	50 Hz or 60 Hz nominal
Nominal Voltage Range	Autoranging 100-240 VAC
Maximum Current AC RMS	15.0 A @ 100 VAC (each power cord)
AC Operating Range	90 - 264 Vrms, 47 - 63Hz
Output	
+3.3 VDC	3 to 72 A
+5 VDC	3 to 56 A
+12 VDC	1 to 35 A
+48 VDC	0 to 31.2 A
Maximum DC Power Output	2240 Watts
Maximum AC Power Consumption	3000 Watts
Maximum Heat Dissipation	10,308 BTU/hr
Volt-Ampere Rating	1515 VA with 1120 Watt load (PF=0.99)

Reference for Environmental Requirements

The operating and non-operating environmental requirements for the system are as follows.

Parameter	Value
Operating	
Temperature	5°C to 35°C (41°F to 95°F)—IEC 68-2-1, 68-2-2
Humidity	20% to 80% RH, noncondensing; 27 °C max wet bulb—IEC 68-2-2, 68-2-3
Altitude	0 to 3000 meters (0 to 10,000 feet)—IEC 68-2-40, 68-2-41
Vibration:	
Deskside	0.0002 g ² /Hz, 5–500 Hz (random)—IEC 68-2-6
Rackmounted	0.00015 g ² /Hz, 5–500 Hz (random)—IEC 68-2-6
Shock:	
Deskside	4 g peak, 11 milliseconds half-sine pulse—IEC 68-2-27
Rackmounted	3 g peak, 11 milliseconds half-sine pulse—IEC 68-2-27
Declared Acoustics	6.7 bels dB(A) operating, 7.6 bels dB(A) at ok prompt
Non-Operating	
Temperature	-20°C to 60°C (-4°F to 140°F)—IEC 68-2-1, 68-2-2
Humidity	95% RH, noncondensing at 40°C—IEC 68-2-2, 68-2-3
Altitude	0 to 12,000 meters (0 to 40,000 feet)—IEC 68-2-40, 68-2-41
Vibration:	
Deskside	0.002 g ² /Hz, 5–500 Hz (random)—IEC 68-2-6
Rackmounted	0.0015 g ² /Hz, 5–500 Hz (random)—IEC 68-2-6
Shock:	
Deskside	15 g peak, 11 milliseconds half-sine pulse—IEC 68-2-27e
Rackmounted	10 g peak, 11 milliseconds half-sine pulse—IEC 68-2-27e
Handling Drops	50 mm—IEC 68-2-31
Threshold Impact	1 m/s—SUN 900-1813

Reference for Agency Compliance Specifications

The system complies with the following specifications.

Category	Relevant Standards
Safety	EN60950/IEC950 TUV UL 1950, CB Scheme IEC 950, C22.2 No. 950 from UL EK from KTL
RFI/EMI	Australia/New Zealand AS/NZ 3548 Class A Industry Canada ICES-003 Class A European Community EN55022 Class A Japan VCCI Class A Taiwan CNS 13438 Class A US FCC 47CFR15.B Class A
Immunity	EN55024 EN61000-4-2 EN61000-4-3 EN61000-4-4 EN61000-4-5 EN61000-4-6 EN61000-4-8 EN61000-4-11
X-ray	US DHHS 21CFR Subchapter J PTB German X-ray Decree

Reference for Clearance and Service Access Specifications

Minimum clearances needed for proper cooling are as follows.

Blockage	Required Clearance
Front blockage only	3.0 in (7.6 cm)
Rear blockage only	3.5 in (8.9 cm)
Front and rear blockage	
Front clearance	3.5 in (8.9 cm)
Rear clearance	4.0 in (10.2 cm)

Minimum clearances needed for servicing the system are as follows.

Area	Required Clearance
Front	
deskside system	36 in (91 cm)
rackmounted system	48 in (122 cm)
Rear	36 in (91 cm)
Right	36 in (91 cm)
Left	36 in (91 cm)

Safety Precautions

This appendix supplies you with reference information about safety precautions you should take when setting up your equipment.

Safety Agency Compliance Statements

Read this section before beginning any procedure. The following text provides safety precautions to follow when installing a Sun Microsystems product.

Safety Precautions

For your protection, observe the following safety precautions when setting up your equipment:

- Follow all cautions and instructions marked on the equipment.
- Ensure that the voltage and frequency of your power source match the voltage and frequency inscribed on the equipment's electrical rating label.
- Never push objects of any kind through openings in the equipment. Dangerous voltages may be present. Conductive foreign objects could produce a short circuit that could cause fire, electric shock, or damage to your equipment.

Symbols

The following symbols may appear in this book:



Caution – There is risk of personal injury and equipment damage. Follow the instructions.



Caution – Hot surface. Avoid contact. Surfaces are hot and may cause personal injury if touched.



Caution – Hazardous voltages are present. To reduce the risk of electric shock and danger to personal health, follow the instructions.



On – Applies AC power to the system.

Depending on the type of power switch your device has, one of the following symbols may be used:



Off - Removes AC power from the system.



Standby – The On/Standby switch is in the standby position.

Modifications to Equipment

Do not make mechanical or electrical modifications to the equipment. Sun Microsystems is not responsible for regulatory compliance of a modified Sun product.

Placement of a Sun Product



Caution – Do not block or cover the openings of your Sun product. Never place a Sun product near a radiator or heat register. Failure to follow these guidelines can cause overheating and affect the reliability of your Sun product.



Caution – The workplace-dependent noise level defined in DIN 45 635 Part 1000 must be 70Db(A) or less.

SELV Compliance

Safety status of I/O connections comply to SELV requirements.

Power Cord Connection



Caution – Sun products are designed to work with single-phase power systems having a grounded neutral conductor. To reduce the risk of electric shock, do not plug Sun products into any other type of power system. Contact your facilities manager or a qualified electrician if you are not sure what type of power is supplied to your building.



Caution – Not all power cords have the same current ratings. Household extension cords do not have overload protection and are not meant for use with computer systems. Do not use household extension cords with your Sun product.



Caution – Your Sun product is shipped with a grounding type (three-wire) power cord. To reduce the risk of electric shock, always plug the cord into a grounded power outlet.

The following caution applies only to devices with a Standby power switch:



Caution – The power switch of this product functions as a standby type device only. The power cord serves as the primary disconnect device for the system. Be sure to plug the power cord into a grounded power outlet that is nearby the system and is readily accessible. Do not connect the power cord when the power supply has been removed from the system chassis.

Lithium Battery



Caution – The Sun Fire 880 system I/O board and RSC card contain lithium batteries. Batteries are not customer replaceable parts. They may explode if mishandled. Do not dispose of the battery in fire. Do not disassemble it or attempt to recharge it.

Battery Pack



Caution – There is a sealed NiMH battery pack in Sun Fire 880 units. There is danger of explosion if the battery pack is mishandled or incorrectly replaced. Replace only with the same type of Sun Microsystems battery pack. Do not disassemble it or attempt to recharge it outside the system. Do not dispose of the battery in fire. Dispose of the battery properly in accordance with local regulations.

System Unit Cover

You must open the side doors of your Sun Fire 880 server to add cards, memory, or internal options. Be sure to close and secure the doors before powering on your system.



Caution – Do not operate your system while the side doors are open. Failure to take this precaution may result in personal injury and system damage.

Laser Compliance Notice

Sun products that use laser technology comply with Class 1 laser requirements.

Class 1 Laser Product
Luokan 1 Laserlaitte
Klasse 1 Laser Apparat
Laser Klasse 1

CD-ROM



Caution – Use of controls, adjustments, or the performance of procedures other than those specified herein may result in hazardous radiation exposure.

Einhaltung sicherheitsbehördlicher Vorschriften

Auf dieser Seite werden Sicherheitsrichtlinien beschrieben, die bei der Installation von Sun-Produkten zu beachten sind.

Sicherheitsvorkehrungen

Treffen Sie zu Ihrem eigenen Schutz die folgenden Sicherheitsvorkehrungen, wenn Sie Ihr Gerät installieren:

- Beachten Sie alle auf den Geräten angebrachten Warnhinweise und Anweisungen.
- Vergewissern Sie sich, daß Spannung und Frequenz Ihrer Stromquelle mit der Spannung und Frequenz übereinstimmen, die auf dem Etikett mit den elektrischen Nennwerten des Geräts angegeben sind.
- Stecken Sie auf keinen Fall irgendwelche Gegenstände in Öffnungen in den Geräten. Leitfähige Gegenstände könnten aufgrund der möglicherweise vorliegenden gefährlichen Spannungen einen Kurzschluß verursachen, der einen Brand, Stromschlag oder Geräteschaden herbeiführen kann.

Symbole

Die Symbole in diesem Handbuch haben folgende Bedeutung:



Achtung – Gefahr von Verletzung und Geräteschaden. Befolgen Sie die Anweisungen.



Achtung – Hohe Temperatur. Nicht berühren, da Verletzungsgefahr durch heiße Oberfläche besteht.



Achtung – Gefährliche Spannungen. Anweisungen befolgen, um Stromschläge und Verletzungen zu vermeiden.



Ein – Setzt das System unter Wechselstrom.

Je nach Netzschaltertyp an Ihrem Gerät kann eines der folgenden Symbole benutzt werden:



Aus – Unterbricht die Wechselstromzufuhr zum Gerät.



Wartezustand (Stand-by-Position) - Der Ein-/Wartezustand-Schalter steht auf Wartezustand. Änderungen an Sun-Geräten.

Nehmen Sie keine mechanischen oder elektrischen Änderungen an den Geräten vor. Sun Microsystems, übernimmt bei einem Sun-Produkt, das geändert wurde, keine Verantwortung für die Einhaltung behördlicher Vorschriften

Aufstellung von Sun-Geräten



Achtung – Um den zuverlässigen Betrieb Ihres Sun-Geräts zu gewährleisten und es vor Überhitzung zu schützen, dürfen die Öffnungen im Gerät nicht blockiert oder verdeckt werden. Sun-Produkte sollten niemals in der Nähe von Heizkörpern oder Heizluftklappen aufgestellt werden.



Achtung – Der arbeitsplatzbezogene Schalldruckpegel nach DIN 45 635 Teil 1000 beträgt 70Db(A) oder weniger.

Einhaltung der SELV-Richtlinien

Die Sicherung der I/O-Verbindungen entspricht den Anforderungen der SELV-Spezifikation.

Anschluß des Netzkabels



Achtung – Sun-Produkte sind für den Betrieb an Einphasen-Stromnetzen mit geerdetem Nulleiter vorgesehen. Um die Stromschlaggefahr zu reduzieren, schließen Sie Sun-Produkte nicht an andere Stromquellen an. Ihr Betriebsleiter oder ein qualifizierter Elektriker kann Ihnen die Daten zur Stromversorgung in Ihrem Gebäude geben.



Achtung – Nicht alle Netzkabel haben die gleichen Nennwerte. Herkömmliche, im Haushalt verwendete Verlängerungskabel besitzen keinen Überlastungsschutz und sind daher für Computersysteme nicht geeignet.



Achtung – Ihr Sun-Gerät wird mit einem dreiadrigen Netzkabel für geerdete Netzsteckdosen geliefert. Um die Gefahr eines Stromschlags zu reduzieren, schließen Sie das Kabel nur an eine fachgerecht verlegte, geerdete Steckdose an.

Die folgende Warnung gilt nur für Geräte mit Wartezustand-Netzschalter:



Achtung – Der Ein/Aus-Schalter dieses Geräts schaltet nur auf Wartezustand (Stand-By-Modus). Um die Stromzufuhr zum Gerät vollständig zu unterbrechen, müssen Sie das Netzkabel von der Steckdose abziehen. Schließen Sie den Stecker des Netzkabels an eine in der Nähe befindliche, frei zugängliche, geerdete Netzsteckdose an. Schließen Sie das Netzkabel nicht an, wenn das Netzteil aus der Systemeinheit entfernt wurde.

Lithiumbatterie



Achtung – CPU-Karten von Sun verfügen über eine Echtzeituhr mit integrierter Lithiumbatterie (Teile-Nr. MK48T59Y, MK48TXXB-XX, MK48T18-XXXPCZ, M48T59W-XXXPCZ, oder MK48T08). Diese Batterie darf nur von einem qualifizierten Servicetechniker ausgewechselt werden, da sie bei falscher Handhabung explodieren kann. Werfen Sie die Batterie nicht ins Feuer. Versuchen Sie auf keinen Fall, die Batterie auszubauen oder wiederaufzuladen.

Batterien



Achtung – Die Geräte Sun Fire 880 enthalten auslaufsichere Bleiakkumulatoren. Produkt-Nr. TLC02V50 für portable Stromversorgung. Werden bei der Behandlung oder beim Austausch der Batterie Fehler gemacht, besteht Explosionsgefahr. Batterie nur gegen Batterien gleichen Typs von Sun Microsystems austauschen. Nicht demontieren und nicht versuchen, die Batterie außerhalb des Geräts zu laden. Batterie nicht ins Feuer werfen. Ordnungsgemäß entsprechend den vor Ort geltenden Vorschriften entsorgen.

Gehäuseabdeckung

Sie müssen die obere Abdeckung Ihres Sun-Systems entfernen, um interne Komponenten wie Karten, Speicherchips oder Massenspeicher hinzuzufügen. Bringen Sie die obere Gehäuseabdeckung wieder an, bevor Sie Ihr System einschalten.



Achtung – Bei Betrieb des Systems ohne obere Abdeckung besteht die Gefahr von Stromschlag und Systemschäden.

Einhaltung der Richtlinien für Laser

Sun-Produkte, die mit Laser-Technologie arbeiten, entsprechen den Anforderungen der Laser Klasse 1.

Class 1 Laser Product
Luokan 1 Laserlaite
Klasse 1 Laser Apparat
Laser Klasse 1

CD-ROM



Warnung – Die Verwendung von anderen Steuerungen und Einstellungen oder die Durchführung von Prozeduren, die von den hier beschriebenen abweichen, können gefährliche Strahlungen zur Folge haben.

Conformité aux normes de sécurité

Ce texte traite des mesures de sécurité qu'il convient de prendre pour l'installation d'un produit Sun Microsystems.

Mesures de sécurité

Pour votre protection, veuillez prendre les précautions suivantes pendant l'installation du matériel :

- Suivre tous les avertissements et toutes les instructions inscrites sur le matériel.
- Vérifier que la tension et la fréquence de la source d'alimentation électrique correspondent à la tension et à la fréquence indiquées sur l'étiquette de classification de l'appareil.
- Ne jamais introduire d'objets quels qu'ils soient dans une des ouvertures de l'appareil. Vous pourriez vous trouver en présence de hautes tensions dangereuses. Tout objet conducteur introduit de la sorte pourrait produire un court-circuit qui entraînerait des flammes, des risques d'électrocution ou des dégâts matériels.

Symboles

Vous trouverez ci-dessous la signification des différents symboles utilisés :



Attention: – risques de blessures corporelles et de dégâts matériels. Veuillez suivre les instructions.



Attention: – surface à température élevée. Évitez le contact. La température des surfaces est élevée et leur contact peut provoquer des blessures corporelles.



Attention: – présence de tensions dangereuses. Pour éviter les risques d'électrocution et de danger pour la santé physique, veuillez suivre les instructions.



MARCHE – Votre système est sous tension (courant alternatif).

Un des symboles suivants sera peut-être utilisé en fonction du type d'interrupteur de votre système:



ARRET - Votre système est hors tension (courant alternatif).



VEILLEUSE – L'interrupteur Marche/Veilleuse est en position « Veilleuse ».

Modification du matériel

Ne pas apporter de modification mécanique ou électrique au matériel. Sun Microsystems n'est pas responsable de la conformité réglementaire d'un produit Sun qui a été modifié.

Positionnement d'un produit Sun



Attention: – pour assurer le bon fonctionnement de votre produit Sun et pour l'empêcher de surchauffer, il convient de ne pas obstruer ni recouvrir les ouvertures prévues dans l'appareil. Un produit Sun ne doit jamais être placé à proximité d'un radiateur ou d'une source de chaleur.



Attention: – Le niveau de pression acoustique au poste de travail s'élève selon la norme DIN 45 635 section 1000, à 70 dB (A) ou moins.

Conformité SELV

Sécurité : les raccordements E/S sont conformes aux normes SELV.

Connexion du cordon d'alimentation



Attention: – les produits Sun sont conçus pour fonctionner avec des alimentations monophasées munies d'un conducteur neutre mis à la terre. Pour écarter les risques d'électrocution, ne pas brancher de produit Sun dans un autre type d'alimentation secteur. En cas de doute quant au type d'alimentation électrique du local, veuillez vous adresser au directeur de l'exploitation ou à un électricien qualifié.



Attention: – tous les cordons d'alimentation n'ont pas forcément la même puissance nominale en matière de courant. Les rallonges d'usage domestique n'offrent pas de protection contre les surcharges et ne sont pas prévues pour les systèmes d'ordinateurs. Ne pas utiliser de rallonge d'usage domestique avec votre produit Sun.



Attention: – votre produit Sun a été livré équipé d'un cordon d'alimentation à trois fils (avec prise de terre). Pour écarter tout risque d'électrocution, branchez toujours ce cordon dans une prise mise à la terre.

L'avertissement suivant s'applique uniquement aux systèmes équipés d'un interrupteur VEILLEUSE:



Attention: – le commutateur d'alimentation de ce produit fonctionne comme un dispositif de mise en veille uniquement. C'est la prise d'alimentation qui sert à mettre le produit hors tension. Veillez donc à installer le produit à proximité d'une prise murale facilement accessible. Ne connectez pas la prise d'alimentation lorsque le châssis du système n'est plus alimenté.

Batterie au lithium



Attention: – sur les cartes CPU Sun, une batterie au lithium (référence MK48T59Y, MK48TXXB-XX, MK48T18-XXXPCZ, M48T59W-XXXPCZ, ou MK48T08.) a été moulée dans l'horloge temps réel SGS. Les batteries ne sont pas des pièces remplaçables par le client. Elles risquent d'exploser en cas de mauvais traitement. Ne pas jeter la batterie au feu. Ne pas la démonter ni tenter de la recharger.

Bloc-batterie



Attention: – Les unités Sun Fire 880 contiennent une batterie étanche au plomb (produits énergétiques portatifs n°TLC02V50). Il existe un risque d'explosion si ce bloc-batterie est manipulé de façon erronée ou mal mis en place. Ne remplacez ce bloc que par un bloc-batterie Sun Microsystems du même type. Ne le démontez pas et n'essayez pas de le recharger hors du système. Ne faites pas brûler la batterie mais mettez-la au rebut conformément aux réglementations locales en vigueur.

Couvercle

Pour ajouter des cartes, de la mémoire, ou des unités de stockage internes, vous devrez démonter le couvercle de l'unité système Sun. Ne pas oublier de remettre ce couvercle en place avant de mettre le système sous tension.



Attention: – il est dangereux de faire fonctionner un produit Sun sans le couvercle en place. Si l'on néglige cette précaution, on encourt des risques de blessures corporelles et de dégâts matériels.

Conformité aux certifications Laser

Les produits Sun qui font appel aux technologies lasers sont conformes aux normes de la classe 1 en la matière.

Class 1 Laser Product
Luokan 1 Laserlaitte
Klasse 1 Laser Apparat
Laser Klasse 1

CD-ROM



Attention: – L'utilisation de contrôles, de réglages ou de performances de procédures autre que celle spécifiée dans le présent document peut provoquer une exposition à des radiations dangereuses.

Normativas de seguridad

El siguiente texto incluye las medidas de seguridad que se deben seguir cuando se instale algún producto de Sun Microsystems.

Precauciones de seguridad

Para su protección observe las siguientes medidas de seguridad cuando manipule su equipo:

- Siga todas los avisos e instrucciones marcados en el equipo.
- Asegúrese de que el voltaje y la frecuencia de la red eléctrica concuerdan con las descritas en las etiquetas de especificaciones eléctricas del equipo.
- No introduzca nunca objetos de ningún tipo a través de los orificios del equipo. Pueden haber voltajes peligrosos. Los objetos extraños conductores de la electricidad pueden producir cortocircuitos que provoquen un incendio, descargas eléctricas o daños en el equipo.

Símbolos

En este libro aparecen los siguientes símbolos:



Precaución – Existe el riesgo de lesiones personales y daños al equipo. Siga las instrucciones.



Precaución – Superficie caliente. Evite el contacto. Las superficies están calientes y pueden causar daños personales si se tocan.



Precaución – Voltaje peligroso presente. Para reducir el riesgo de descarga y daños para la salud siga las instrucciones.



Encendido – Aplica la alimentación de CA al sistema.

Según el tipo de interruptor de encendido que su equipo tenga, es posible que se utilice uno de los siguientes símbolos:



Apagado - Elimina la alimentación de CA del sistema.



En espera – El interruptor de Encendido/En espera se ha colocado en la posición de En espera.

Modificaciones en el equipo

No realice modificaciones de tipo mecánico o eléctrico en el equipo. Sun Microsystems no se hace responsable del cumplimiento de las normativas de seguridad en los equipos Sun modificados.

Ubicación de un producto Sun



Precaución – Para asegurar la fiabilidad de funcionamiento de su producto Sun y para protegerlo de sobrecalentamientos no deben obstruirse o taparse las rejillas del equipo. Los productos Sun nunca deben situarse cerca de radiadores o de fuentes de calor.



Precaución – De acuerdo con la norma DIN 45 635, Parte 1000, se admite un nivel de presión acústica para puestos de trabajo máximo de 70Db(A).

Cumplimiento de la normativa SELV

El estado de la seguridad de las conexiones de entrada/salida cumple los requisitos de la normativa SELV.

Conexión del cable de alimentación eléctrica



Precaución – Los productos Sun están diseñados para trabajar en una red eléctrica monofásica con toma de tierra. Para reducir el riesgo de descarga eléctrica, no conecte los productos Sun a otro tipo de sistema de alimentación eléctrica. Póngase en contacto con el responsable de mantenimiento o con un electricista cualificado si no está seguro del sistema de alimentación eléctrica del que se dispone en su edificio.



Precaución – No todos los cables de alimentación eléctrica tienen la misma capacidad. Los cables de tipo doméstico no están provistos de protecciones contra sobrecargas y por tanto no son apropiados para su uso con computadores. No utilice alargadores de tipo doméstico para conectar sus productos Sun.



Precaución – Con el producto Sun se proporciona un cable de alimentación con toma de tierra. Para reducir el riesgo de descargas eléctricas conéctelo siempre a un enchufe con toma de tierra.

La siguiente advertencia se aplica solamente a equipos con un interruptor de encendido que tenga una posición "En espera":



Precaución – El interruptor de encendido de este producto funciona exclusivamente como un dispositivo de puesta en espera. El enchufe de la fuente de alimentación está diseñado para ser el elemento primario de desconexión del equipo. El equipo debe instalarse cerca del enchufe de forma que este último pueda ser fácil y rápidamente accesible. No conecte el cable de alimentación cuando se ha retirado la fuente de alimentación del chasis del sistema.

Batería de litio



Precaución – En las placas de CPU Sun hay una batería de litio insertada en el reloj de tiempo real, tipo SGS Núm. MK48T59Y, MK48TXXB-XX, MK48T18-XXXPCZ, M48T59W-XXXPCZ, o MK48T08. Las baterías no son elementos reemplazables por el propio cliente. Pueden explotar si se manipulan de forma errónea. No arroje las baterías al fuego. No las abra o intente recargarlas.

Paquete de pilas



Precaución – Las unidades Sun Fire 880 contienen una pila de plomo sellada, Productos de energía portátil n° TLC02V50. Existe riesgo de estallido si el paquete de pilas se maneja sin cuidado o se sustituye de manera indebida. Las pilas sólo deben sustituirse por el mismo tipo de paquete de pilas de Sun Microsystems. No las desmonte ni intente recargarlas fuera del sistema. No arroje las pilas al fuego. Deséchelas siguiendo el método indicado por las disposiciones vigentes.

Tapa de la unidad del sistema

Debe quitar la tapa del sistema cuando sea necesario añadir tarjetas, memoria o dispositivos de almacenamiento internos. Asegúrese de cerrar la tapa superior antes de volver a encender el equipo.



Precaución – Es peligroso hacer funcionar los productos Sun sin la tapa superior colocada. El hecho de no tener en cuenta esta precaución puede ocasionar daños personales o perjudicar el funcionamiento del equipo.

Aviso de cumplimiento con requisitos de láser

Los productos Sun que utilizan la tecnología de láser cumplen con los requisitos de láser de Clase 1.

Class 1 Laser Product
Luokan 1 Laserlaite
Klasse 1 Laser Apparat
Laser Klasse 1

CD-ROM



Precaución – El manejo de los controles, los ajustes o la ejecución de procedimientos distintos a los aquí especificados pueden exponer al usuario a radiaciones peligrosas.

GOST-R Certification Mark

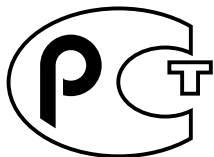

Nordic Lithium Battery Cautions

Norge



ADVARSEL – Litiumbatteri —
Ekspløsjonsfare. Ved utskifting benyttes kun
batteri som anbefalt av apparatfabrikanten.
Brukt batteri returneres apparatleverandøren.

Sverige



VARNING – Explosionsfara vid felaktigt
batteribyte. Använd samma batterityp eller
en ekvivalent typ som rekommenderas av
apparatillverkaren. Kassera använt batteri
enligt fabrikantens instruktion.

Danmark



ADVARSEL! – Litiumbatteri —
Ekspløsjonsfare ved fejlagtig håndtering.
Udskiftning må kun ske med batteri af samme
fabrikat og type. Levér det brugte batteri
tilbage til leverandøren.

Suomi



VAROITUS – Paristo voi räjähtää, jos se on
virheellisesti asennettu. Vaihda paristo
ainoastaan laitevalmistajan suosittelemaan
tyyppiin. Hävitä käytetty paristo valmistajan
ohjeiden mukaisesti.

Index

A

- abort key sequence, *See* Stop-a keyboard combination
- AC power cord
 - connecting, 25, 40
 - when to disconnect, 27, 31
- agency compliance specifications, 198
- air baffle, CPU, 63
- AL_PAs, 101
- alphanumeric terminal, 4, 46
 - attaching, 46
 - settings for, 46
- antistatic
 - precautions, 31
 - wrist strap, 32
- ASCII terminal, *See* alphanumeric terminal
- .asr command, 129, 135 to 137
- ASR, *See* automatic system recovery (ASR)
- asr-disable command, 129, 132 to 136
- asr-enable command, 129, 134, 135
- auto-boot? configuration parameter, 58, 60, 127 to 130
- auto-boot-on-error? configuration parameter, 127 to 131
- automatic system recovery (ASR), 126 to 137
 - deconfiguring devices manually, 132, 133
 - disabling, 131
 - enabling, 127, 130
 - obtaining status information, 136, 137
 - overview, 18, 126
 - reconfiguring devices manually, 134, 135

B

- backplane, *See* FC-AL disk backplane
- banks of memory, 64
- baud rate, 47, 79
- boot device, how to select, 116
- boot-device configuration parameter, 116, 128
- booting
 - after installing new hardware, 55
 - with failed hardware components, 126
- boxes shipped to you, 24
- Break key, 56
 - disabling, 13

C

- cables
 - Gigabit Ethernet, 112
 - keyboard/mouse, 50
 - serial port splitter cable, 47
 - twisted-pair Ethernet (TPE), 114
- cautions and warnings, 201 to 210
- CD, *See* compact disc
- cfgadm command, 147
- chassis ground screw, 9
- checklist of parts, 24
- clearance specifications, 198, 199
- cluster configurations, 157
- compact disc
 - cleaning, 179
 - ejecting in an emergency, 177

- ejecting manually, 175
- ejecting with software commands, 173
- inserting into drive, 171
- when drive cannot read, 179

compact PCI (cPCI) cards, 70

concatenation of disks, 153

configuration, *See* hardware configuration

connector specifications, 187 to 193

console, *See* system console

Control-C, 121

conventions used in this book, xvi

correctable ECC error, 20

CPU fan tray, *See* fan tray assemblies

CPU/Memory board, 2, 62, 63

- air baffle, 63
- configuration guidelines, 62, 63
- CPU numbering, 62
- slot status LEDs, 160

D

damage, preventing

- electrostatic, 31, 66
- to tape cartridges, 181

dealias command, 132 to 134

device trees, rebuilding, 56

diag-console command, 58, 60

diagnostic testing, 4, 13, 21, 52, 57, 137

- role in automatic system recovery, 126 to 129

diag-switch? configuration parameter, 128 to 130, 138, 139

diag-trigger configuration parameter, 128 to 130

digital versatile disc

- cleaning, 179
- ejecting in an emergency, 177
- ejecting manually, 175
- ejecting with software commands, 173
- inserting into drive, 171
- when drive cannot read, 179

dimensions, *See* specifications

DIMM, *See* memory modules

disc, compact, *See* compact disc

disc, digital versatile, *See* digital versatile disc

disk backplane, *See* FC-AL disk backplane

disk configuration

- concatenation, 153
- configuration guidelines, 97, 98
- hot spares, 20, 155
- hot-plug, 15, 97, 144 to 147, 156
- mirroring, 20, 153
- RAID 0, 20, 93, 154
- RAID 1, 20, 154
- RAID 5, 20, 93, 155
- striping, 20, 93, 154

disk drive, 3, 97, 98

- access door, 7
- configuration guidelines, 97, 98
- dual-ported, 20, 92 to 96, 97
- hot-plug, 3, 15, 92, 97, 144 to 147, 156
- installing, 33 to 35
- LEDs, 6, 11, 98, 166
- locating drive bays, 6, 98
- removing, 36 to 38
- storage capacities, 97

documentation

- online, 28
- related, xvii

door lock, 7

dual-loop FC-AL configurations, 3, 20, 92 to 96, 99

DVD, *See* digital versatile disc

DVD-ROM drive, 3, 78, 170 to 180

- location, 6
- specifications, 170

Dynamic Multipathing (DMP), 93, 148, 152

Dynamic Reconfiguration (DR), 146

E

EIA-232D serial communications, 27, 79, 82

EIA-423 serial communications, 27, 79, 82

eject cd command, 173, 176

ejecting a CD or DVD, 173 to 176

electrical specifications, 196

electrostatic damage, preventing, 31

emergency eject (of a CD or DVD), 178

emergency shutdown, 12, 13

.env command, 121, 124, 125

- environmental monitoring subsystem
 - See also* OpenBoot environmental monitor
 - and hot-swap events, 145
 - and RSC, 4, 71
 - automatic thermal shutdown, 17, 63, 77, 121
 - error messages, 17, 121, 145
 - monitoring for fan faults, 17, 76, 120, 121, 145
 - monitoring for power faults, 17, 120, 145
 - temperature monitoring, 16, 120, 121
- environmental specifications, 197
- `env-off` command, 120, 123
- `env-on` command, 56, 120, 122
- `eri` Fast Ethernet driver, 104, 107, 111
- error correcting code (ECC), 20
- error messages
 - correctable ECC error, 20
 - fan-related, 17, 145
 - log file, 17
 - power-related, 17, 145
 - temperature-related, 17
- `/etc/hostname` file, 109
- `/etc/hosts` file, 110
- Ethernet, 3, 103 to 118
 - See also* Fast Ethernet port, Gigabit Ethernet port
 - adding an interface, 108
 - cable requirements, 112, 114
 - configuring interface, 27, 103 to 118
 - drivers, 104, 107, 111
 - link integrity test, 107, 111
 - redundant network interfaces, 105
 - twisted-pair cable, attaching, 114
 - using multiple interfaces, 3, 104, 105
- external storage, 3, 99, 100

F

- failover capability, 3, 5, 15, 16, 92, 104, 105, 152
- fan tray assemblies
 - configuration guidelines, 75 to 77
 - CPU fan tray filler panel, 76
 - hot-swap capability, 16, 76, 144 to 147
 - LEDs, 76, 164
 - location, 75
 - primary versus secondary, 75
 - redundancy, 16, 75
 - See also* fans

- fans
 - See also* fan tray assemblies
 - fault monitoring and reporting, 16, 17, 76, 145
- Fast Ethernet port, 3, 104
 - See also* Ethernet
 - attaching twisted-pair cable, 114
 - location, 8
 - pin and signal specifications, 190
- fault indicators, *See* status LEDs
- FC-AL
 - administration, 156
 - arbitrated loop physical address (AL_PA), 101
 - technology overview, 90, 91
- FC-AL disk backplane, 3, 92 to 96
 - configuration guidelines, 95, 96
 - dual-loop configuration, 3, 20, 92 to 96, 99
 - jumpers, 86
- FC-AL disk drive, *See* disk drive
- FC-AL host adapter, 3, 20, 92 to 96, 99, 100
 - configuration guidelines, 99, 100
- Fibre Channel-Arbitrated Loop, *See* FC-AL
- filler panel
 - CPU air baffle, 63
 - CPU fan tray, 76
 - power supply, 39, 43
- firmware updates, 83, 156
- flash PROM
 - jumpers, 83 to 87
 - programming, 83
 - disabling, 13, 85, 156
- foot strap, antistatic, 31
- frame buffer card, 4, 45
- front panel features, 6
- `fuser` command, 173, 176

G

- `ge` Gigabit Ethernet driver, 104, 107, 111
- Gigabit Ethernet port, 3, 104
 - See also* Ethernet
 - cabling requirements, 112
 - LEDs, 168
 - location, 8
- grounding screw, 8, 9

H

- hardware configuration, 61 to 87
 - CPU/Memory boards, 62, 63
 - disk drives, 97, 98
 - fan tray assemblies, 75 to 77
 - FC-AL disk backplanes, 95, 96
 - FC-AL host adapters, 99, 100
 - hardware jumpers, 81 to 87
 - FC-AL disk backplane, 86
 - flash PROM, 83 to 87
 - Remote System Control card, 87
 - serial ports, 82
 - memory, 64 to 67
 - PCI cards, 68 to 70
 - power supplies, 73, 74
 - Remote System Control card, 71
 - removable media devices, 78
 - SCSI devices, 78
 - serial ports, 79
 - USB ports, 80
- hardware jumpers, *See* jumpers
- hardware redundancy, 3, 4, 15, 16, 70, 75, 92, 104, 105
- hardware watchdog, 18
 - enabling, 19
- host name, 106, 108
- hot spares, *See* disk configuration
- hot-plug feature
 - definition, 144
 - disk drives, 3, 15, 92, 97, 144 to 147, 156
 - OK-to-Remove LED, 11, 161, 164, 166
 - PCI cards, 2, 15, 68, 70, 144 to 147
 - user interfaces, 147, 156
- hot-swap feature
 - definition, 144
 - fan tray assemblies, 16, 144 to 147
 - power supplies, 16, 144 to 147

I

- I/O board, 19, 27, 69, 72, 79, 81 to 85, 94, 104, 146, 150, 189, 190
 - jumpers, 82, 84
- I/O bridge fan tray, *See* fan tray assemblies
- I/O fan tray, *See* fan tray assemblies
- I²C bus, 16

- input-device configuration parameter, 58, 60, 139
- installing a server, 25 to 28
- interleaving, memory, 65, 67
- internal disk drive bays, locating, 6, 98
- internet protocol (IP) address, 106, 109
- IP Network Multipathing, 105
- ISP2100 processor, 100
- ISP2200A processor, 99, 100

J

- jumpers, 81 to 87
 - FC-AL disk backplane, 86
 - flash PROM jumpers, 83 to 87
 - Remote System Control (RSC) card, 87
 - serial port jumpers, 82

K

- key lock, 7
- keyboard, attaching, 48
- keyboard/mouse connector, location, 8
- keyswitch
 - Diagnostics position, 13, 51, 85
 - Forced Off position, 13, 54
 - effect on RSC, 13, 54
 - location, 6, 10
 - Locked position, 13, 85, 156
 - monitoring and control, 16
 - Normal position, 13, 51, 85
 - settings, 13

L

- LEDs, *See* status LEDs
- link integrity test, 107, 111
- log files
 - error, 17
 - RSC, 19
- luxadm utility, 145, 156

M

- mat, antistatic, 31
- memory modules, 2, 64
 - banks of, 64
 - capacities, 2, 64
 - configuration guidelines, 64 to 67
 - handling, 66
 - memory interleaving, 65, 67
- mirroring, disk, 20, 153
- monitor, attaching, 48
- motherboard, 3, 62, 68, 75, 78, 94, 99, 104, 146
- motherboard fan tray, *See* fan tray assemblies
- mouse, attaching, 48
- MPEG-2, 63
- multipathing software, 3, 92, 105, 142, 146, 148, 152

N

- network
 - See also* Ethernet
 - configuring interface, 27, 103 to 118
 - name server, 110
 - primary interface, 106, 107
 - redundant interfaces, 105
 - types, 27
- NVRAM configuration parameters
 - auto-boot?, 58, 60, 127 to 130
 - auto-boot-on-error?, 127 to 131
 - boot-device, 116, 128
 - diag-switch?, 128 to 130, 138, 139
 - diag-trigger, 128 to 130
 - input-device, 58, 60, 139
 - output-device, 58, 60, 139
 - resetting to default values, 138, 139

O

- ok prompt, *See* OpenBoot firmware
- OK-to-Remove LED, 11, 160, 161, 164, 166
- online documentation, 28
- OpenBoot Diagnostics, 4, 13, 21, 52, 56, 71
 - role in automatic system recovery, 126 to 129
- OpenBoot emergency procedures, 138 to 140

- OpenBoot environmental monitor, 56, 120 to 125
 - See also* Environmental monitoring subsystem
 - automatic thermal shutdown, 121
 - disabled by Stop-a keyboard command, 56, 120, 123
 - disabling, 56, 120, 123
 - enabling, 56, 120, 122
 - obtaining status information, 121, 124, 125
- OpenBoot firmware, 4, 58, 60, 116, 119 to 140
- operating system software, installing, 28, 107
- options, installing, 26
- output-device configuration parameter, 58, 60, 139
- overtemperature conditions, 16, 121

P

- parity, 20, 47, 155
- parts checklist, 24
- PBCs, 96
- PCI bridge chips, 68 to 70
- PCI buses, 2, 68 to 70
 - availability considerations, 70, 105
 - configuration guidelines, 68 to 70
 - parity protection, 20
 - performance considerations, 70
 - slot characteristics, 68
- PCI card
 - configuration guidelines, 68 to 70
 - device names, 117, 133
 - frame buffer card, 4, 45, 48
 - host adapters, 3, 20, 92 to 96, 99, 104
 - hot-plug operations, 2, 15, 68, 70, 144 to 147
 - slot characteristics, 68
 - slot locations, 8, 69
 - slot status LEDs, 69, 161
- Peripheral Component Interconnect, *See* PCI card, PCI buses
- physical specifications, 196
- port bypass controllers (PBCs), 96
- .post command, 137
- power
 - LED indicator, 11, 53
 - specifications, 196
 - turning off, 53
 - turning on, 51

- Power button, 12, 51, 53, 56, 135
 - disabling, 13
 - location, 6, 10
- power cord, AC
 - connecting, 25, 40
 - when to disconnect, 27, 31
- power distribution board, 39, 73
- Power Fault LED, 12, 17
- power supply, 4, 8
 - configuration guidelines, 73, 74
 - DC output voltages, 74
 - fault monitoring and reporting, 17, 145
 - filler panel, 39, 43
 - hot-swap capability, 5, 16, 74
 - installing, 39 to 41
 - LEDs, 9, 12, 17, 41, 74, 163
 - location, 8, 73
 - output capacity, 4, 74, 196
 - redundancy, 4, 15, 74, 144
 - removing, 42 to 44
- power-on self-test (POST), 4, 13, 21, 52, 56, 71, 137
 - role in automatic system recovery, 126 to 129
- precautions, safety, 201 to 210

Q

- Qlogic ISP2100 processor, 100
- Qlogic ISP2200A processor, 99, 100

R

- rackmount kit, 5
- RAID, *See* disk configuration
- rear panel features, 8
- reconfiguration boot, 55, 63
- redundancy, *See* hardware redundancy
- redundant cooling option, 75, 76
- reliability, availability, and serviceability (RAS), 5, 14 to 21
- Remote System Control (RSC), 4, 8, 19, 150, 151
 - and keyswitch Forced Off position, 13, 54
 - battery, 4, 71, 150
 - card location, 8
 - connector locations, 72
 - connector specifications, 191 to 193

- Ethernet port, 72, 150, 191
- features, 4, 19, 71, 72, 150
- hardware configuration, 71
- jumpers, 87
- modem port, 72, 150, 192
- overview, 4, 19, 71, 72
- recovering from failed RSC console, 59
- redirecting system console to, 58
- serial port, 72, 150, 151, 193
- software installation, 28, 72
- user interfaces, 151
- User's Guide, 28
- removable media devices, 3, 78
 - configuration, 78
- reset -all command, 58, 60, 118, 130, 131, 133, 135, 145
- RSC, *See* Remote System Control (RSC)

S

- safety agency compliance, 198
- safety precautions, 201 to 210
- SBus cards, 70
- SCSI
 - configuration guidelines, 78
 - parity protection, 20
 - target IDs, 78
- SCSI Enclosure Services (SES) processor, 96
- security features, 7, 10, 13
- serial ports, 4, 79
 - configuring, 27, 79, 82
 - connecting to, 47
 - jumpers, 82
 - location, 8
 - pin and signal specifications, 188
 - splitter cable, 4, 47, 79
- server installation, 25 to 28
- server media kit, contents of, 28
- service access specifications, 198, 199
- SES processor, 96
- shipping (what you should receive), 24
- show-devs command, 117, 132, 133
- shutdown, 12, 13, 17, 53, 63, 77, 121
- side door, removing, 29, 30

- Solaris operating environment, 3, 4, 72, 104, 105, 145, 146, 156
 - installing, 28, 107
 - Solstice DiskSuite, 20, 92, 143, 152, 153
 - specifications, 187 to 198
 - agency compliance, 198
 - clearance, 198, 199
 - connector, 187 to 193
 - DVD-ROM drive, 170
 - electrical, 196
 - environmental, 197
 - Ethernet cable requirements, 112, 114
 - physical, 196
 - service access, 198, 199
 - SSC-100 processor, 96
 - status and control panel, 10
 - location, 6
 - status LEDs, 10 to 12, 21, 159 to 168
 - behavior during POST, 11
 - CPU/Memory board slots, 160
 - disk drive LEDs, 6, 98, 166
 - Disk Fault LED, 11, 166
 - environmental fault indicators, 17
 - fan tray LEDs, 76, 164
 - Gigabit Ethernet LEDs, 168
 - location, 10, 159 to 168
 - meaning, 11, 159 to 168
 - OK-to-Remove LED, 11, 160, 161, 164, 166
 - PCI slots, 69, 161
 - Power Fault LED, 12, 17
 - Power LED, 11
 - power supply LEDs, 9, 12, 17, 41, 74, 163
 - System Fault LED, 11, 17
 - Thermal Fault LED, 12, 17, 164
 - Stop-a keyboard combination, 56, 120, 123, 138, 139
 - disables OpenBoot environmental monitor, 56, 120, 123
 - disabling, 13
 - Stop-d keyboard combination, 140
 - Stop-f keyboard combination, 140
 - Stop-n keyboard combination, 139
 - striping of disks, 20, 93, 154
 - Sun Cluster software, 157
 - Sun Management Center software, 21, 142, 149, 150
 - Sun StorEdge PCI Dual Fibre Channel Host
 - Adapter card, 99, 100
 - Sun Validation Test Suite (SunVTS), 21
 - SunSolve Online web site, 83
 - system banner, 56
 - system configuration, *See* hardware configuration
 - system console, 4, 27, 45
 - redirecting to local console, 60
 - redirecting to RSC, 58
 - setting up, 45
 - System Fault LED, 11, 17
 - system features, 2 to 21
 - front panel, 6
 - rear panel, 8
 - system interconnect bus, 63
 - system specifications, *See* specifications
- ## T
- tape cartridge
 - ejecting, 183
 - handling, 181
 - inserting into drive, 182
 - magnetic fields and, 181
 - storing, 181
 - sunlight and, 181
 - write-enabling, 182
 - write-protecting, 182
 - tape drive, 78
 - cleaning, 185
 - controlling with software commands, 184
 - temperature sensors, 16
 - terminal, alphanumeric, 4, 46
 - Thermal Fault LED, 12, 17, 164
 - thermal shutdown, 17, 63, 77, 121
 - tip connection, 45, 56
 - twisted-pair Ethernet port, *See* Fast Ethernet port
 - typographic conventions, xvi
- ## U
- UltraSPARC III CPU, *See* CPU/Memory board
 - undertemperature conditions, 16
 - universal PCI card, 70

- Universal Serial Bus ports, 4, 50, 80
 - hardware configuration, 80
 - hot-plug feature, 80
 - location, 8
 - pin and signal specifications, 189
 - USB hubs, 80
- USB, *See* Universal Serial Bus ports
- user interfaces, 151

V

- VERITAS Volume Manager, 20, 92, 93, 143, 148, 152, 153
- Visual Instruction Set, 2, 63

W

- warnings and cautions, 201 to 210
- watchdog, hardware, 18
 - enabling, 19
- weight, *See* specifications
- wrench LED, *See* System Fault LED, status LEDs
- wrist strap, antistatic, 31, 32
- write-enabling a tape cartridge, 182
- write-protecting a tape cartridge, 182