

# Console Server *800*

User Manual

30 May 2001



Lightwave Communications  
[www.lightwavecom.com](http://www.lightwavecom.com)

Lightwave Communications, Inc.  
100 Washington Street Milford, CT 06460 USA  
(800) 871-9838 • (203) 878-9838 • Fax: (203) 874-0157  
Email: [info@lightwavecom.com](mailto:info@lightwavecom.com) • Internet: [www.lightwavecom.com](http://www.lightwavecom.com)

---

LCI Asia/Pacific  
Postal address: P.O. Box 19 Glen Iris VIC 3146 Australia  
Delivery address: 16 Network Drive Port Melbourne VIC 3207 Australia  
+61 3 9646 1144 • Fax: +61 3 9645 3377  
Email: [sales@lightwavecom.com.au](mailto:sales@lightwavecom.com.au) • Internet: [www.lightwavecom.com.au](http://www.lightwavecom.com.au)

---

LCI Europe  
Zaubzerstraße 11 Munich D-81677 Germany  
+49-89-306-3810 • Fax: +49-89-306-3812  
Email: [office@lightwave.de](mailto:office@lightwave.de) • Internet: [www.lightwave.de](http://www.lightwave.de)

1.0	System Description .....	1
1.1	Features.....	1
2.0	System Overview .....	2
2.1	Typical Use .....	2
2.2	System Components .....	2
2.3	Access Control.....	2
2.4	Connection Formats .....	2
2.4.1	Serial.....	2
2.4.2	Network.....	2
2.4.3	Modem .....	3
2.5	Device Port Buffer .....	3
3.0	Installation.....	4
3.1	Environmental Requirements .....	4
3.2	Physical Installation .....	4
3.3	Power.....	5
3.3.1	AC .....	5
3.3.2	DC.....	6
3.4	Connecting a Terminal .....	7
3.5	Connecting to the Device Port.....	8
3.6	Connecting the Network Port.....	9
3.7	Connecting the Modem Port.....	10
3.8	Installing a Modem Card.....	11
4.0	ConsoleServer 800 Administration .....	14
4.1	Power-up Sequence and Basic Use of the Administrator Functions.....	14
4.1.1	Logging In, Serial Connection.....	15
4.1.2	Logging In, Network Connection.....	16
4.1.3	Logging Out .....	16
4.1.4	System Help.....	16
4.1.5	Changing the Administration Password.....	18
4.2	Creating and Managing Users.....	19
4.3	Devices Command.....	22
4.4	Network Command.....	23
4.5	Modem Command .....	24
4.6	Status Commands .....	25
4.6.1	CONNECTIONS Command .....	25
4.6.2	VERSION Command .....	26
4.6.3	INFO Command.....	27
4.6.4	POWERSTATUS Command .....	28
4.7	Administrator Session Management Commands.....	28
4.7.1	LINESPERPAGE Command .....	29
4.7.2	TIMEOUT Command .....	29
4.8	Breaking User Connections.....	29
4.8.1	FORCELOGOUT Command .....	30
4.8.2	TELNETTIMEOUT Command .....	30
4.8.3	MODEMTIMEOUT Command .....	31
4.9	Saving and Restoring System Settings .....	31
4.10	Changing the System Prompt.....	32
4.11	Updating the ConsoleServer 800 Software .....	33
5.0	User Access and Functions .....	34
5.1	Terminal Port .....	34
5.2	Network Port .....	34
5.3	Modem Card.....	35
5.3.1	Ending a Modem Session .....	35
5.4	Overview of Commands .....	35
5.5	Logging In and Changing Passwords.....	37

5.6	Logging Out .....	38
5.7	Checking Connections.....	39
5.8	Selecting a Device Port .....	39
5.9	Direct Mode .....	41
5.10	Using the Buffer .....	42
5.11	The Break Generation Sequence .....	44
6.0	REBOOT Command .....	46
7.0	LCD Front Panel .....	47
Appendix A – Terminal Port, Device Port, and Adapter Pinouts .....		48
Appendix B – Flash Update Procedure .....		53
B.1	Introduction .....	53
B.2	Requirements .....	53
B.3	Getting Started .....	53
B.3.1	Communications Settings .....	53
B.4	Update over Direct Serial Connection .....	54
B.5	Update over Network.....	55
Appendix C – System Specifications .....		57
C.1	Physical .....	57
C.2	Environmental.....	57
C.3	Electrical .....	57
C.3.1	AC Power.....	57
C.3.2	DC Power.....	57
C.4	Interface.....	58
C.4.1	Terminal and Device .....	58
C.4.2	Network .....	58
C.4.3	Modem .....	58
C.5	Compliance and Certification.....	58
C.6	Identification of Exterior Components .....	59
Appendix D – DC Power Specifications.....		60
D.1	DC Power Source .....	60
D.2	Overcurrent Protection .....	60
D.3	DC Supply Connector .....	60
Appendix E – Command Abbreviations .....		62
Appendix F – Hexadecimal ASCII Code .....		64

ConsoleServer 800 User Manual

Edition of 30 May 2001

Copyright 2000-2001 Lightwave Communications, Inc.

100 Washington Street, Milford, CT, 06460, USA

All rights reserved. No part of this copyrighted material may be reproduced in any form or by any means without prior written permission from Lightwave Communications, Inc.



## 1.0 System Description

The ConsoleServer 800 provides a compact solution for remote and local management of up to eight devices with RS-232C compatible serial consoles. As many as ten users may simultaneously access different consoles through the ConsoleServer.

The ConsoleServer 800 is factory-configured with eight device ports, one local terminal port, one network connection, and can have an optional modem card. The unit can be configured at time of manufacture for either universal AC operation or –48 VDC operation. Both power supply configurations feature redundant power supplies.

All system parameters are stored in non-volatile data flash memory. User profiles, port configurations, and other system parameters are saved even when the unit is not powered. A maximum of 50 user profiles may be stored per system.

The system software held in flash memory can be updated while the unit is installed. The ConsoleServer will not send breaks to the attached servers during the flash update process. Updates are sent to the unit using either a serial connection to the terminal port (using the Xmodem or Kermit file transfer protocols), or by a tftp download through the network port. See Appendix B for further details and the flash update procedure.

### 1.1 Features

- Connect up to eight RS-232C serial consoles
- No unintentional break will ever be sent to attached servers
- 64KB of buffered data storage per device port
- Local access through terminal port
- Remote access through network and optional modem
- 1 RU (1.75 inches) high
- Redundant power supplies

## **2.0 System Overview**

### **2.1 Typical Use**

The ConsoleServer 800 is typically used to manage up to eight rack-mounted servers or switches where rack space is at a premium. Each attached device must have an RS-232C compatible serial console port.

### **2.2 System Components**

All system components are enclosed in a rack-mountable metal chassis. Each chassis is factory-configured with eight device ports, one terminal port, and one network port. An optional modem card is available. Power supplies are factory-installed, and may be either for universal AC operation, or for –48 VDC operation. The ConsoleServer 800 front panel features an LCD display and two push buttons for access to system information.

### **2.3 Access Control**

Access to attached servers is controlled by assigning access rights to system user profiles. Each user profile is assigned an ID, a password, I/O rights. Users must have a user profile to access any of the attached devices.

### **2.4 Connection Formats**

#### **2.4.1 Serial**

All devices attached to both the device ports and the terminal port must support the RS-232C standard. The serial communications parameters may be set by the system administrator to match the attached equipment.

Be sure to use Lightwave RJ45 to DB25 or DB9 adapters to assure the proper transmission of serial signals. Appendix A contains the pinouts for the RJ45 serial connectors and adapters.

#### **2.4.2 Network**

The ConsoleServer 800 network interface connects to a TCP/IP network using standard RJ45-terminated Cat 5 cables. The network must use IPv4. The point of connection to the network must operate at 10 Mbits half duplex, with no auto-negotiation.

The network parameters must be configured by the system administrator through the terminal port before the ConsoleServer may be accessed over the network.

### **2.4.3 Modem**

The optional modem card connects to a POTS line using standard RJ11 modular telephone cable. The analog modem on the card connects at speeds up to 38,400 baud.

### **2.5 Device Port Buffer**

Each device port stores 64 KB (approximately 100 screens) of I/O data in a FIFO buffer. This data is viewed while the user is not directly interacting with the attached device.

## 3.0 Installation

### 3.1 Environmental Requirements

Maximum operating temperature:	125°F (52°C)
Minimum operating temperature:	32°F (0°C)
Operating humidity range:	30% to 90% RH, non-condensing

Maximum storage temperature:	158°F (70°C)
Minimum storage temperature:	-4°F (-20°C)
Storage humidity range:	10% to 90% RH, non-condensing

Heat generated under normal operation: 34.1 BTU/hour

The ConsoleServer 800 uses convection cooling to dissipate the majority of its excess heat. Be careful not to block the air vents on the sides of the unit. If mounted in an enclosed rack, it is recommended that the rack have a ventilation fan to provide adequate airflow through the unit.

### 3.2 Physical Installation

The ConsoleServer 800 may be installed either in an EIA-standard 19 inch rack or as a desktop unit. If the unit is used as a desktop unit, then four rubber feet (included) should be applied to the underside of the unit to prevent scratching of the desk surface.

#### Rack Mount Instructions:

##### Materials Required:

- ConsoleServer 800
- EIA-standard 19 inch rack
- screws to fit rack
- screwdriver

1. Choose the mounting location for the ConsoleServer. Avoid placing the ConsoleServer in a location where its side vents will be blocked, or where the ConsoleServer would block another unit's ventilation holes.
2. Slide the unit between the rack uprights and align the mounting holes. It may be helpful to have two people for this step and the next one.

3. Insert mounting screws into each hole and tighten. Check to make sure that the unit is seated snugly against the rack uprights. Proceed with the power, network, terminal, and device installation outlined below.

### 3.3 Power

For both the AC and DC versions, the ConsoleServer 800 consumes approximately **10 W** of electrical power.

#### 3.3.1 AC

The AC version of the ConsoleServer 800 uses universal auto-switching AC power supplies. The power supplies accept AC input voltage between 85 and 264 VAC with a frequency between 47 and 440 Hz. A country-specific power cord is included with the unit; additional cords are available from Lightwave if required.



AC power input

#### Installation:

##### Materials:

- ConsoleServer 800
  - included power cable
  - power outlet
1. Select a power outlet for the ConsoleServer. It may be desirable to provide an uninterrupted power source (UPS) for the unit.
  2. Connect the provided AC cable to the rear of the ConsoleServer.
  3. Connect the other end of the power cable to the selected power outlet.

### 3.3.2 DC

The DC version of the ConsoleServer 800 accepts standard –48 VDC telco power. The ConsoleServer accepts two DC power inputs for supply redundancy.

See Appendix D for specifications regarding the DC power source.



DC power inputs

#### Installation:

##### Materials:

- small flat-blade screwdriver
- wire stripper
- ConsoleServer 800 DC power connector kit
- wires to 48 VDC power (see Appendix D for specifications)

1. Turn off the circuit breaker to the DC power supply.
2. Select a three-wire set (-48V, –48 Return, and Power Supply Ground) from the power supply.
3. Strip 0.35 inches (89 mm) of insulation from each wire.
4. Insert a small flat-blade screwdriver in the provided connector.
5. Insert the appropriate wire into the connector. Remove the screwdriver.
6. Attach the provided strain relief to the connector. Be sure to use a tie-wrap to firmly attach the strain relief to the cable.

7. Attach the connector to the socket on the back of the ConsoleServer. Repeat the above steps if a redundant power input is to be attached.

### 3.4 Connecting a Terminal

The terminal port is used for local access to the ConsoleServer 800 and the attached devices. The system administrator must also use the terminal port to set up the configuration for the network port before the ConsoleServer 800 can be accessed from the network. A dumb terminal or computer may be attached to the serial port if the serial port uses RS-232-C protocol and vt100 emulation is supported.

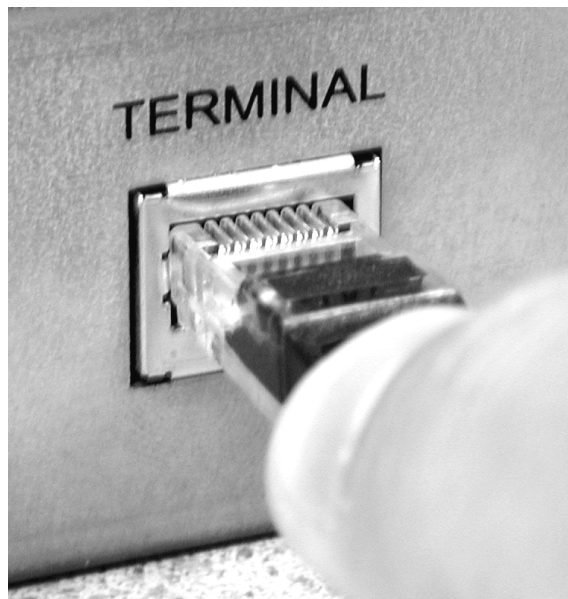

Inserting a cable in the terminal port

The default communication parameters for the terminal port are: **9600 baud, 8 data bits, 1 stop bit, no parity, Xon/Xoff flow control, and a port type of DCE.**

Adapters from Lightwave Communications must be used to connect the terminal port to the serial port on a terminal. Otherwise, the serial pin signals may not match and there will be no communication between the two units. See Appendix A for adapter and port pinouts.

## Installation:

### Materials:

- ConsoleServer 800 terminal port
- terminal or computer with RS-232 serial port
- RJ45-terminated Cat 5 cable (standard LAN cable)
- Lightwave adapter for terminal serial port

1. Attach the Lightwave adapter to the terminal or computer serial port.
2. Connect the Cat 5 cable to the adapter. Connect the other end to the ConsoleServer 800 terminal port.
3. Turn on the terminal or start the computer's communication program. Make sure that the communication parameters of the terminal or computer match those of the terminal port (see above).

### **3.5 Connecting to the Device Port**

Any device that has a serial console port (such as a server or a switch) may be connected to the ConsoleServer for consolidated remote administration. The console port must support the RS-232-C serial protocol. Additionally, many servers must either have the serial port enabled as a console, or must have the keyboard and mouse detached. Consult the server hardware and/or software documentation for more information.



Inserting a cable in the device port



The default communication parameters for the device port are: **9600 baud, 8 data bits, 1 stop bit, no parity, Xon/Xoff flow control, and a port type of DCE**. Most equipment that uses serial console ports uses values complimentary to the above settings, so it is not usually necessary to change the device port parameters.

Adapters from Lightwave Communications must be used to connect the device port to a serial console port. Otherwise, the serial pin signals may not match and there will be no communication between the two units. See Appendix A for adapter and port pinouts.

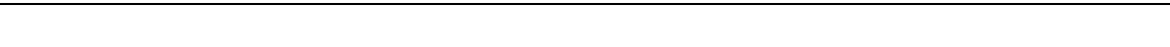

### Installation:

#### Materials:

- ConsoleServer 800 device port
- device with RS-232-C serial console port
- RJ45-terminated Cat 5 cable (standard LAN cable)
- Lightwave adapter for serial console port

1. Attach the Lightwave adapter to the serial console port.
2. Connect the Cat 5 cable to the adapter. Connect the other end to the ConsoleServer 800 device port.
3. Check that the device port and serial console port communications parameters match, and synchronize them if they do not match. See sections 4.3 and 4.6.3 for more information regarding the device port parameters.

### **3.6 Connecting the Network Port**

The ConsoleServer 800's network port allows remote access to the attached devices and the system administrative functions. Up to eight remote users may telnet to the ConsoleServer, along with one remote administrator.

#### **NOTE:**

**The point of connection for the ConsoleServer (e.g., a network switch) must run at 10 Mbits, half-duplex with no auto-negotiation. It is imperative that there is no auto-negotiation of the connection speed, as this will prevent the establishment of a functioning network connection.**

It is also recommended that the network run pure TCP/IP, and not a combination of protocols.

The network parameters for the network port must first be set up through the serial terminal port before the ConsoleServer 800 may be reached remotely. See section 4.4 for more information.

### Installation:

#### Materials:

- ConsoleServer 800 network port
  - network point-of-connection
  - RJ45-terminated Cat 5 cable (standard LAN cable)
1. Configure the ConsoleServer network parameters to the desired values as outlined in section 4.4.
  2. Configure the network point-of-connection. It must be manually set to 10 Mbits, half-duplex, with no auto-negotiation.
  3. Connect the ConsoleServer network port to the network using a standard LAN cable.
  4. Check the status lights at each end of the connection. Both should indicate a good link. Try reaching the IP address assigned to the ConsoleServer by using PING or TELNET. If there is a problem, check the network configuration.

### **3.7 Connecting the Modem Port**

An optional modem port is available for the ConsoleServer 800. The modem may be installed at the factory or can be ordered separately for later installation. See section 3.8 for the procedure to install a modem card in a previously purchased system.

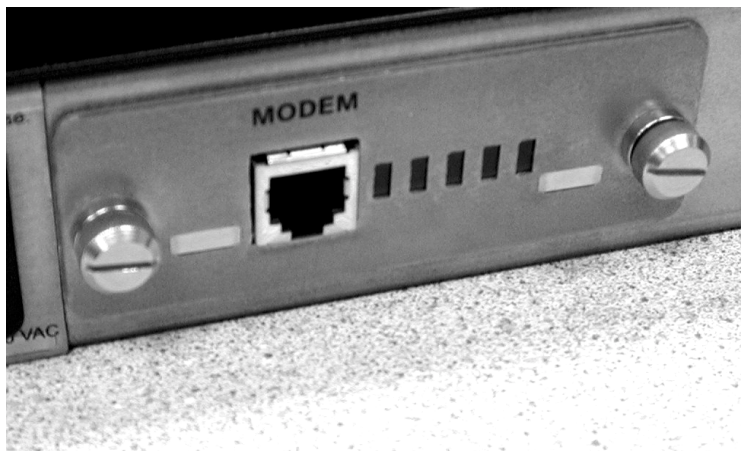

ConsoleServer 800 modem port

The ConsoleServer 800 modem is a POTS analog modem supporting connection rates up to 38,400 baud. The user interface to the modem is identical to that found on the terminal port or the network port.

### Installation:

#### Materials:

- ConsoleServer 800 modem port
  - analog telephone line
  - RJ11 modular telephone cable
1. Locate a modular jack for the telephone line to be used. Select a telephone cable with sufficient length to reach between the jack and the ConsoleServer.
  2. Connect one end of the telephone cable to the jack. Connect the other end to the ConsoleServer modem port.
  3. Make sure the ConsoleServer is powered. Dial the telephone number of the line connected to the ConsoleServer. The modem should automatically answer. If not, check the telephone line and connections.

### **3.8 Installing a Modem Card**

A modem card may be installed on a previously installed ConsoleServer 800. The card is hot-swappable, so it is not necessary to power down the unit before installing the modem card.

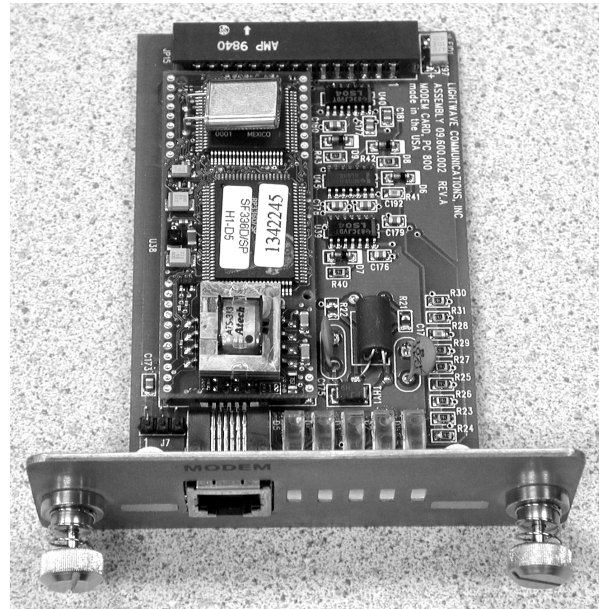

ConsoleServer 800 modem card

### Installation:

#### Materials:

- ConsoleServer 800 without modem card
- ConsoleServer 800 modem card



Remove the modem panel

1. Remove the metal plate covering the modem slot on the rear of the ConsoleServer.

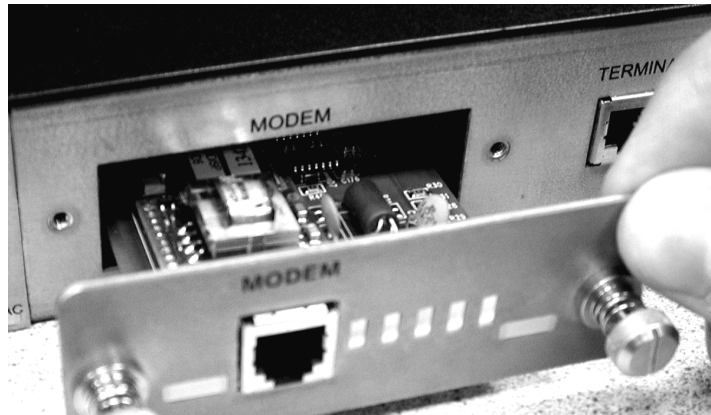

Insert the modem card

2. Insert the modem card into the open slot and seat flush to the rear of the ConsoleServer.

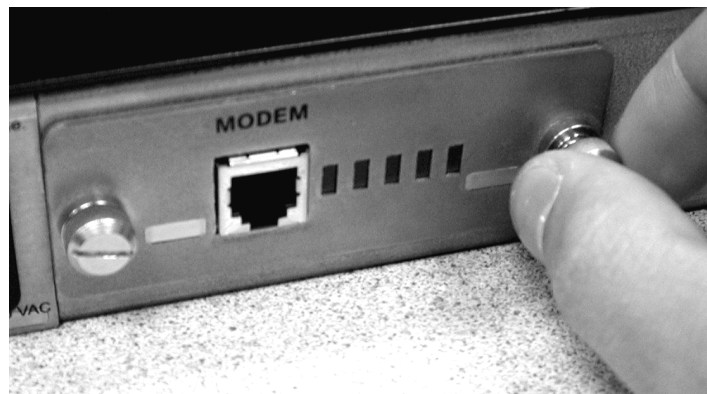

Tighten screws on modem card

3. Tighten the screws on the modem card by hand.

Follow the instructions in section 3.7 to connect the modem port to the telephone network.

## 4.0 ConsoleServer 800 Administration

The following section outlines the administration functions and commands. The administration functions and commands are designed to enable the administrator to configure the ConsoleServer 800 to fit the needs of the system application. User IDs, devices, terminals and access rights may be configured using the administration commands. As new features are added to the product, the administration user will also be used to install new flash memory software updates (see section 4.10, Updating the ConsoleServer 800 Software, and Appendix B).

**The administrator may not access device ports; only users may access device ports (see section 5.0, User Access and Interface).**

Screen shots of interactive terminal sessions are shown in outlined boxes, while in-text command words and system responses are in a different font to differentiate them from normal text. All system commands require the <ENTER> key to respond, but are not case-sensitive unless otherwise specified.

Many commands may be abbreviated to one extent or another, but some may not be abbreviated at all. For example, the command VERSION may be abbreviated to VER, but LCIUPDATE may not be abbreviated. See Appendix E for more information regarding abbreviations.

### **NOTE:**

<ESC> <ESC> or <CTRL>+C will cancel an operation and return to the administrator prompt. Pressing <CTRL>+R at the LCI800> or sys admin> prompt will discard the characters on the current command line, and retype the last command used; <ENTER> must still be pressed to execute the command. Pressing <CTRL>+U at either prompt erases the current command line back to the prompt.

## 4.1 Power-up Sequence and Basic Use of the Administrator Functions

When the ConsoleServer 800 is first installed and powered up, it must be configured through the serial terminal port. Connect the terminal port to a terminal device or computer using a terminal emulation program (refer to section 3.4 for instructions on connecting to the terminal port). After the network interface has been configured (see section 4.4), the administration login may also be reached via telnet. All the functions available from a local serial connection (with the exception of BACKUP and RESTORE) are also available through telnet by connecting to port 5000 of a ConsoleServer's network IP address. Administration access via modem is not supported at this time.

The serial terminal will display the following text at power-up:

```
ConsoleServer800 Boot V1.20
Copyright 2000 by Lightwave Communications, Inc. All rights reserved.
Identify Flash
Flash ID OK
Verifying Flash Image
Starting system
Lightwave Communications, Inc. ConsoleServer800
Please wait...system initializing
Checking non-volatile memory...
2048
Start checking and reading stored data
Reading User Start up .....

LCI800>
```

The power-on self-test may be skipped by pressing <ESC> <ESC> or <CTRL>+C, but the ConsoleServer 800 should be allowed to complete the POST if possible (this check usually takes about three minutes). This information is not available on a network connection, as it is not possible to connect to the ConsoleServer via telnet until the power-on self-test is complete. At the completion of the power-up sequence, the administrator is logged out, as indicated by the LCI800> prompt. Some commands may be used from this prompt, but most are available only when logged in.

**NOTE:**

The administrator may define the system prompt using the PROMPT command (see section 4.10), but the system default prompt (LCI800>) is used in this manual for clarity.

#### 4.1.1 Logging In to System Administration Using Serial Connection

```
LCI800>login
Please enter User ID: root
Please enter password: ****
sys admin>
```

To log in on the ConsoleServer through a local serial connection, type LOGIN at the LCI800> prompt. The system returns the prompt Please enter User ID:. Enter the administrator user ID, **root**. The system will then return Please enter password:. The default administrator password is **PASS** (see section 4.1.5 to change the administrator password). The ConsoleServer will only echo stars when the password is entered. If the user ID and password are correct, the prompt will change to sys admin>.

## 4.1.2 Logging In, Network Connection

```
UNIX_MACHINE# telnet 172.16.1.200 5000
Connecting to 172.16.1.200 port 5000...
Escape sequence is '^]'
welcome to the ConsoleServer800 sysAdmin
LCI800>login
Please enter password: ****
sys admin>
```

To log in on the ConsoleServer through a network connection, the network interface for the ConsoleServer first must be configured through the serial terminal (see section 4.4). Once the network interface is configured and functioning, telnet to port 5000 of the IP address assigned to the ConsoleServer. The ConsoleServer will display a welcome message and the LCI800> prompt. At the prompt, type LOGIN. The system will only prompt for the password. At the Please enter password: prompt, enter the administration password. The default administrator password is PASS (see section 4.1.5 to change the administrator password). The ConsoleServer will only echo stars when the password is entered. If the password is correct, the prompt will change to sys admin>.

## 4.1.3 Logging Out

To log out from an administration session, enter the command LOGOUT or LOGOFF. If logging out from a network session, the ConsoleServer will disconnect the telnet session. If logging out from a direct serial session, the ConsoleServer will return to the LCI800> prompt.

## 4.1.4 System Help

To access the help screens, type <F1> H, ?, or HELP to display the help page. There are two different help screens to reflect the commands available if the administrator is logged in or logged out.



## LOGGED OUT HELP SCREEN

```
LCI800>HELP
F1 - Display Help Screen (VT100 mode)
F2 - Display Pull Down Menu (VT100 mode)
TTY COMMANDS:(LOGGED OUT MODE)
LOGIN - Login with ID and Password
INFO - Display System Info
REBOOT - Perform a warm boot, requires root password

LCI800>
```

## LOGGED IN HELP SCREEN

```
sys admin>HELP
ConsoleServer800 Sys Admin Command List
[] - optional <> - parameter must be specified
| - OR
ABBREVIATIONS - Show list of command abbreviations
ADDUSER [new user id] - Add a new user
BACKUP - Backup internal database
(db will be output using ASCII)
CHANGEPSWD - Change the sys admin password
CONNECTIONS [/MONITOR] - Show list of current connections
(/monitor will auto-refresh)
DELETEUSER [existing user id] - Delete a user
DEVICES - Display device settings
DEVICES [/ALL|n|device name] (n can be 1 to 32) - change settings
EDITUSER [existing user id] - Edit a user's settings
FORCELOGOUT <terminal channel>- Force a user off the system
FORCELOGOUT sysadmin - Force logout a sys admin
session on network.
INFO - Report miscellaneous information
LCIUPDATE [/tftp] - Start system update process
(requires update file(s))
/tftp - used only at console port, when system updates are
transferred using the network.
LINESPERPAGE [n] - Display/set number of lines before pause
(n can be 0 to 99, 0 disables)
LISTDEVICES - Show list of device names
LISTUSERS [user id|/ALL] - Display list of users
LOGOUT,LOGOFF - Logout
MODEM [/DEFAULT] - Display/set modem init string
/DEFAULT - set init string to default
MODEMTIMEOUT [t] - Display/set timeout for modem calls
(t can be 0 to 30 minutes, 0 disables)
NETWORK [/EDIT] - Display/set network parameters
POWERSTATUS - Show status of power supplies
REBOOT - Perform a warm boot, requires root password
RESTORE - Restore internal database
(upload ASCII file)
TELNETTIMEOUT [t] - Display/set timeout for telnet sessions
(t can be 0 to 30 minutes, 0 disables)
tftp [get] host:file - Modified tftp command, used to
transfer new updates to this box
TIMEOUT [t] - Display/set timeout on sys admin login
(t can be 0 to 9 minutes, 0 disables)
VERSION - Report software version information

sys admin>
```

A listing of abbreviations for the administrator commands is also available when connected to the administrator port. The ABBREVIATIONS command is only available when logged in.

```

sys admin>ABBREVIATIONS
  ConsoleServer800 Sys Admin Command Abreviations List
ABBREVIATIONS      - A
ADDUSER            - ADDU
                   AU
BACKUP             - (no abbreviation)
CHANGEPSWD        - PASSWD
                   PSWD
CONNECTIONS       - C
DELETEUSER        - DELETEU
DEVICES           - DEV
EDITUSER          - EDITU
                   EU
FORCELOGOUT       - (no abbreviation)
HELP              - H, ?
INFO              - (no abbreviation)
LCIUPDATE         - (no abbreviation)
LINESPERPAGE      - LINESPP
                   LINES
                   LPP
LISTDEVICES       - LISTD
                   LD
LISTUSERS         - LISTU
                   LU
LOGIN             - LOGI
LOGOUT            - LO
MODEM             - (no abbreviation)
MODEMTIMEOUT     - MODEMT
                   MT
NETWORK           - NET
POWERSTATUS      - PO
                   PS
REBOOT            - (no abbreviation)
RESTORE           - (no abbreviation)
TELNETTIMEOUT    - TELNETT
                   TT
TIMEOUT           - TIME
VERSION           - VER

```

#### 4.1.5 Changing the Administration Password

At the first login, the ConsoleServer 800 will use the factory default password, PASS (all upper case). This default password should be changed as soon as possible to prevent access by anyone other than authorized personnel.

```

sys admin>passwd
Please enter current root password >****
Please enter new root password >*****
Please re-enter new root password >*****

sys admin>

```

To change the sys admin factory default password, type CHANGEPSWD or PASSWD at the sys admin> prompt. The new password may be up to ten alphanumeric characters long and is case-sensitive.

## 4.2 Creating and Managing Users

The ADDUSER command creates user IDs and privileges. The following screen will be displayed when the command is used:

```
sys admin>>ADDUSER
Number of available user records: 50
Number of users defined: 0
Enter user id | USER ID >usr1
```

Press <ENTER> after typing the user ID. The user name is not case-sensitive. The next prompt asks for a password for the user ID. When the user logs in for the first time he will be asked for this password. This password is case-sensitive and is pre-expired. The user must change the password before accessing any of the ConsoleServer 800 device ports. The user password may be up to 10 alphanumeric characters long, and may not contain the "\*" character. The ConsoleServer 800 will echo only stars when the administrator enters the password and confirmation

```
Enter case sensitive password | PASSWORD > ****
Re-enter case sensitive password | PASSWORD > ****
0-10 | MAX CONCURRENT LOGINS: 1>2
```

This parameter limits the number of simultaneous logins a user may have. The administrator may select between 0 and 10 concurrent logins. A user with 0 logins will have connect and listen permissions defined, but cannot login to access anything until a number of logins greater than 0 is defined.

```
Allowed devices example: 1-5,8 | DEVICES 0 > 1,5,7,8
```

The administrator is now prompted to define the device ports that the user will be allowed to access for direct connections. If more than one port is to be allowed, then the individual ports must be separated by a comma. A range of ports may be specified using the dash ("-").

Allowed devices determines which devices a user may select for direct access.

The Allow user to clear device buffer (Y/N) | YES > option determines whether a user may use the CLEAR command to delete all the data stored in a device port FIFO buffer. The administrator may want to inhibit this ability to preserve user accountability when accessing attached devices. Users are allowed to clear buffers by default. Pressing <ENTER> will allow the user to clear the buffer; typing NO and then pressing <ENTER> at the prompt when defining a user ID will disallow the user from clearing all device buffers.

The Clear screen after a command (Y/N) | YES > option determines if the screen clears when most commands are executed. Disallowing this screen behavior keeps the last few commands and responses on the terminal screen. The default value for this option is YES. Pressing <ENTER> will accept the default value; typing NO and then pressing <ENTER> disallows this screen behavior.

```
sys admin>adduser
Number of available user records: 50
Number of users defined: 0
Enter user id | USER ID > usr1
Enter case sensitive password | PASSWORD > ***
Re-enter case sensitive password | PASSWORD > *****
0-10 | MAX CONCURRENT LOGINS: 1>2
Allowed devices example: 1-5,8 | DEVICES 0 > 1-8
Allow user to clear device buffer (Y/N) | YES >
Clear screen after a command (Y/N) | YES >
Enter user id | USER ID >

sys admin
```

The above procedure has defined one user. The ConsoleServer 800 will prompt for the next user ID to be defined. Repeat the set-up process until all users have been entered. To return to the administrator prompt, simply press <ENTER> at the USER ID> prompt. More users may be added at any time by using the ADDUSER command. A maximum of 50 users can be defined.

```
sys admin>EDITUSER TOM
Enter accepts present value
Enter case sensitive password | PASSWORD >
0-10 | MAX CONCURRENT LOGINS: 2>6
Allowed devices example: 1-5,8 | DEVICES 1-4 >
Allow user to clear device buffer (Y/N) | YES > n
Clear screen after a command (Y/N) | NO > n

sys admin>
```

To edit or change parameters for a particular user after defining that user ID, use the EDITUSER command. For example, if the user 'Tom' needed to have more concurrent login capabilities, the administrator would type EDITUSER TOM on the command line. As each line comes up, change the settings and press <ENTER>, or press <ENTER> to accept the current setting.

NOTE: When editing any group of parameters, pressing the <ENTER> key will accept the current value and move to the next parameter in the list.

```

sys admin>LISTUSERS
1: User id > PETE
2: User id > KEVIN
3: User id > TONY

sys admin>>LISTUSERS /ALL
1: User id > PETE
Allowed devices > 1-8
Max logins > 1
Allow user to clear device buffer > YES
Clear screen after a command > YES
2: User id > KEVIN
Allowed devices > 1-8
Max logins > 1
Allow user to clear device buffer > YES
Clear screen after a command > YES
3: User id > TONY
Allowed devices > 1-8
Max logins > 1
Allow user to clear device buffer > YES
Clear screen after a command > YES

sys admin>

```

To list the users that have been defined, use the LISTUSERS command. When used alone, the command will display all user ID's. When a user ID is specified after the command, the parameters for that user ID will be displayed. If the /ALL qualifier is included after the LISTUSERS command, then the parameters for all users are displayed.

```

sys admin>DELETEUSER PETE
Delete user:pete                               Yes or No (N):y

sys admin>listusers
2: User id > KEVIN
3: User id > TONY

sys admin>

```

To delete a user, use the DELETEUSER command, followed by the user ID on the same line. The LISTUSERS command will allow verification after deleting a user ID. The above command sequence is an example of the use of DELETEUSER with LISTUSERS.

```

sys admin> deleteuser /3
Delete user:tony                               Yes or No (N):y

sys admin>

```

User IDs may also be deleted by their record number. As each user ID is created, it is assigned a sequential record number. This number is associated with the user ID and will be displayed using the LISTUSER command. To delete a user ID using the record number, specify the number as a qualifier after the

DELETEUSER command in the form DELETEUSER /N, where N is the user record number.

### 4.3 Devices Command

```
sys admin>DEVICES 1
Enter accepts present value
D1: Enter device name | NAME DEVICE_1 >
D1: 0=9600, 1=19200, 2=38400, 3=57600 | BAUD RATE: 9600>
D1: 0=1, 1=2 | STOP BITS: 1>
D1: 0=None, 1=Odd, 2=Even, 3=Mark, 4=Space | PARITY: None>
D1: 0=8, 1=7, 2=6 | DATA BITS: 8>
D1: 0=DCE, 1=DTE | EQUIP PORT TYPE: DCE>
D1: 0=XON/OFF, 1=DTR/DSR, 2=RTS/CTS | FLOW CONTROL: XON/XOFF>
D1: 0=No, 1=Yes | INHIBIT DIRECT MODE: No>

sys admin>
```

Device port parameters must be defined by the administrator using the DEVICES command. If a single device port is to be changed, the port number must follow the DEVICES command. If the DEVICES command is entered by itself, the configuration of all device ports will be listed. To edit all possible device ports for a unit, enter the command DEVICES /ALL.

Programmable elements include: device name, baud rate, stop bits, parity, data bits, DCE/DTE, flow control and inhibit direct mode. Pressing <ENTER> accepts the parameter as is. If changes need to be made, each parameter may be edited as it comes up after each > prompt.

The device name may not contain the \* character. If a name is entered with this character, the administrator will be asked to re-enter the name.

Four baud rates are offered: 9600, 19200, 38400, and 57600. Most devices use 9600 as the console/admin port baud rate, so the device port defaults to this value. Check the equipment documentation for the proper baud rate.

The format of the bit-wise transmission of data is determined by the stop bits, parity, and data bits parameters. The default settings are 1 stop bit, no parity, and 8 data bits. Check the equipment documentation for the proper settings.

Each device port may be separately configured as either DCE or DTE. The DCE setting is used when connecting to a DTE device such as a computer. The DTE setting is used when connecting to a DCE device such as a managed switch. The device ports are configured as DCE by default.

The device port flow control setting determines the method of flow control. The two most common settings are XON/XOFF (a.k.a. software) and RTS/CTS (a.k.a. hardware). DTR/DSR is used very infrequently. The default setting for the

device ports is XON/XOFF. Check the equipment documentation for the correct flow control setting.

The INHIBIT DIRECT MODE setting allows the administrator to turn off port buffering while a user is connected to the device and is in direct mode. The device port buffer still collects data while not in direct mode when this setting is active. It may be desirable to disable direct mode buffering so sensitive data is not viewable by other users, but alert and panic messages from the attached device are still stored when nobody is connected. This setting is disabled by default, so buffer data is collected both in and out of direct mode.

A list of device port names and their corresponding port number may be displayed by using the LISTDEVICES command.

#### 4.4 Network Command

The NETWORK command will define the primary and secondary configuration for the ConsoleServer network interface. The primary configuration will define the network port's IP address, local subnet mask, and default gateway. The secondary configuration allows the administrator to define a routing path to reach a specific destination network via an alternate gateway that has a better route to that destination network. The network administrator for the ConsoleServer 800 will determine if it is necessary to use this feature. If the secondary configuration will not be used, all fields for the secondary configuration should be set to 255.255.255.255 (which is the default setting).

The NETWORK command will either display the network settings of the network interface or change those settings depending on which command qualifier is used.

```
sys admin>NETWORK
IP address           | 000.000.000.000>
Subnet Mask         | 255.255.255.255>
Enter Default Gateway address | 255.255.255.255>
Enter 2nd Dest. Network | 255.255.255.255>
Enter 2nd Netmask    | 255.255.255.255>
Enter 2nd Gateway address | 255.255.255.255>
BOOTP at startup?   | Y>

sys admin>
```

When used by itself, the NETWORK command will display the network settings assigned to the network port. The IP address, subnet mask, default gateway, secondary route, and bootp settings are displayed.

```

sys admin>>NETWORK /EDIT
Enter accepts present value
Enter IP address          | 000.000.000.000> 172.16.1.1
Enter Subnet Mask        | 255.255.255.255> 255.255.255.0
Enter Default Gateway address | 255.255.255.255> 172.16.1.200
Enter 2nd Dest. Network  | 255.255.255.255>
Enter 2nd Netmask        | 255.255.255.255>
Enter 2nd Gateway address | 255.255.255.255>
BOOTP at startup?       | Y>
Save changes? "Yes" or "No": No>yes

sys admin>>

```

When the NETWORK command is used with the /EDIT command qualifier, it will change the port parameters.

If a bootp server is present on the same network as the ConsoleServer 800 network card and bootp is enabled on the network port, then the network port will use the IP address and subnet mask assigned by the bootp server rather than those assigned by the administrator.

Once a network card has been assigned an IP address either by a bootp server or by the administrator, then the ConsoleServer may be accessed by telnet. Connecting to the default telnet port reaches the user login; connecting to port 5000 reaches the administrator login.

## 4.5 Modem Command

The MODEM command allows manipulation of the modem card initialization string. When the command is entered, the administrator is prompted for the new initialization string. Typing a new initialization string and pressing <ENTER> will create a new initialization string for the modem, while just pressing <ENTER> will accept the current value. After pressing <ENTER>, the administrator is asked to confirm the changes to send the string to the modem. Typing YES and <ENTER> will send the initialization string immediately to the modem card, while typing NO and <ENTER> discards the entered initialization string and keeps the old string. If the modem card is not currently installed, the settings are not sent, but are kept in memory. The system will send those settings in memory when a modem card is installed.



```
sys admin>>MODEM
Enter accepts present value
Init string | > ATB2H0
Save changes and update modem card? Yes or No: No>yes
Modem card not installed in slot A, init string saved

Sys admin>MODEM /DEFAULT
Current modem init string is: ATB2H0
Set modem to factory default value of: ATH0S0=1
(write out YES) Yes or No: No>yes
Modem card not installed in slot A, init string saved

sys admin>>
```

The administrator may also reset the initialization string to the default value by entering the command with the default qualifier in the form `MODEM /DEFAULT`. When using the `/DEFAULT` qualifier, the current initialization string is displayed, along with the factory default string. The administrator is asked to confirm the use of the default modem string; typing YES and <ENTER> will send the default initialization string immediately to the modem card, while typing NO and <ENTER> keeps the old modem string.

It is recommended that the default modem initialization string be used unless the application requires that it be changed. The default initialization string is `ATH0S0=1`, which disconnects any active phone connections when the initialization string is sent, and sets the modem to auto-answer on one ring.

## **4.6 Status Commands**

There are four commands which allow the administrator to check the status of the ConsoleServer 800: `CONNECTIONS`, `VERSION`, `INFO`, and `POWERSTATUS`.

### **4.6.1 CONNECTIONS Command**

The administrator may monitor the status of connections made through the terminal, network port, and modem port by using the `CONNECTIONS` command. This command will display all the active connections and the mode of those connections as follows:

```

sys admin>CONNECTIONS
Terminal Connection List
T Kevin          01 Server          ( Monitor mode )
M                00                ( Installed )
N1              00                ( Inactive )
N2              00                ( Inactive )
N3              00                ( Inactive )
N4              00                ( Inactive )
N5              00                ( Inactive )
N6              00                ( Inactive )
N7              00                ( Inactive )
N8              00                ( Inactive )

sys admin>

```

The above example shows that user KEVIN is logged in on the terminal port, is connected to device port 01 (which is named "Server" in the ConsoleServer 800), and is in monitor mode. The list will display the user ID of any logged-in users, the device port to which they are connected, the device name assigned to that port, and the mode of that connection (see sections 5.10 and 5.11 for an explanation of the various connection modes). If the user is not connected to any device, they shall simply be listed as "User Logged-In".

When used with the /MONITOR command line qualifier, the CONNECTIONS command updates the connection list on screen every time a user logs in or out or changes login level (i.e., goes into direct mode), rather than simply displaying the list once as occurs when the CONNECTIONS command is used alone. Connection list update does not apply towards the interaction required to delay a TIMEOUT logout (see section 4.7, Administrator Session Management Commands).

#### 4.6.2 VERSION Command

```

sys admin>VERSION
ConsoleServer800 Boot: v1.20
Application: v1.24

sys admin>

```

The VERSION command displays the version number of the ConsoleServer 800 boot code and application code. The boot code provides the basic system operation, while the application code provides the user interface. The boot code is held in static memory and cannot be updated in the field. The application code is held in flash memory and can be updated. See Appendix B for the flash update procedure.

### 4.6.3 INFO Command

```
sys admin>INFO
Sys admin: logins: 1
Sys admin: tftp not in progress current host:file ==>
0 Active Telnet Sessions Timeout = 5 mins. 0 SysAdmin Sessions
Ethernet Address: 00-30-31-00-0B-13 IP source is 800
IP=192.168.1.121 SM=255.255.255.0 GW=192.168.1.1
Modem: No Active Call Current State: In command mode
Modem: Timeout = 1 mins.
Modem: Init String: ATH0S0=1
Modem error: none
Device Port: D1 DCE 9600,N,8,1 FLOW=XON/OFF RTS=0 DTR=0
Device Port: D2 DCE 9600,N,8,1 FLOW=XON/OFF RTS=0 DTR=0
Device Port: D3 DCE 9600,N,8,1 FLOW=XON/OFF RTS=0 DTR=0
Device Port: D4 DCE 9600,N,8,1 FLOW=XON/OFF RTS=0 DTR=0
Device Port: D5 DCE 9600,N,8,1 FLOW=XON/OFF RTS=0 DTR=0
Device Port: D6 DCE 9600,N,8,1 FLOW=XON/OFF RTS=0 DTR=0
Device Port: D7 DCE 9600,N,8,1 FLOW=XON/OFF RTS=0 DTR=0
Device Port: D8 DCE 9600,N,8,1 FLOW=XON/OFF RTS=0 DTR=0

Terminal Port: T DCE 9600,N,8,1 FLOW=XON/OFF RTS=1 DTR=1
Modem Port: M DCE 38400,N,8,1 FLOW=RTS/CTS RTS=1 DTR=1

sys admin>
```

The INFO command displays miscellaneous system information. Device port settings, network port settings, and other system data are reported.

The network port will return the following information:

- The amount of active telnet sessions
- The telnet session timeout limit
- The amount of network administrator connections
- The unique hardware (MAC) address of the card, expressed as six groups of one-byte hexadecimal numbers
- The source of the network port IP address (internal or external)
- The primary IP information, including: IP address, subnet mask, and gateway
- The secondary IP information, including: destination address, subnet mask, and gateway

The modem card will return the following information:

- The connection status of the modem
- The current modem session timeout limit (see Section 6.9, Breaking User Connections)
- The current modem state, listed as either power-up mode or command mode
- The modem initialization string sent at startup
- Any miscellaneous modem error messages

The terminal and device ports will return the following information:

- The terminal or device port number
- The port letter as indicated on card label
- Equipment port type (DCE or DTE)
- Baud rate
- Parity; N=none, E=even, O=odd, M=mark, S=space
- Data bits
- Stop bits
- Flow control type
- Status of RTS line; 0=off, 1=on
- Status of DTR line; 0=off, 1=on

The labels “RTS” and “DTR” do not change when the port type is changed from DCE to DTE. When the port type is changed, the label “RTS” indicates the status of the CTS line, and “DTR” indicates the status of the DSR line.

#### 4.6.4 POWERSTATUS Command

```
sys admin>POWERSTATUS
Power supply A is OK
Power supply B is OK

sys admin>
```

The POWERSTATUS command displays the status of the two redundant power supplies in the ConsoleServer 800 chassis. Power supplies will either be listed as OK or Failed. The ConsoleServer 800 will continue to function with one failed power supply. Contact Lightwave for information regarding replacement if a power supply fails.

#### 4.7 Administrator Session Management Commands

The ConsoleServer 800 features two commands that allow the administrator to manage properties of the control port terminal session.

### 4.7.1 LINESPERPAGE Command

```
sys admin>LINESPERPAGE
Lines per page set to 22

sys admin>LINESPERPAGE 10
Lines per page set to 10

sys admin>
```

The LINESPERPAGE command allows the administrator to change the number of lines displayed per terminal page on the control card port before the more prompt is displayed. The number of lines to display per page is entered after the command. Entering the command without a number following will display the current amount of lines displayed per page. The default value is 22, which will work properly with a 24-line display.

### 4.7.2 TIMEOUT Command

```
sys admin>>TIMEOUT
Timeout set to 1 minutes

sys admin>>TIMEOUT 0
Timeout set to 0 minutes
0 disables the timeout from occurring

sys admin>>TIMEOUT 5
Timeout set to 5 minutes

sys admin>>
```

The TIMEOUT command allows the administrator to define a time limit on how long an idle administration session may remain logged in. If there is no interaction for the defined amount of time, the system will log out the administrator. The time limit in minutes is entered as a command qualifier after the command, and must be entered as a whole number. Defining the time limit as 0 will disable this function. The default value is one minute.

## 4.8 Breaking User Connections

The administrator has four commands available to forcibly break user connections to devices. The commands BREAK and FORCELOGOUT allow the administrator to break any connection on demand, while TELNETTIMEOUT and MODEMTIMEOUT automatically break idle user sessions for the network or modem card.

### 4.8.1 FORCELOGOUT Command

```
sys admin>FORCELOGOUT 1
Force this user off? (write out YES) Yes or No: No>yes
sys admin>
```

The FORCELOGOUT command causes the forcible logout of a user at any level of connection. The user will be returned to the LCI800> prompt after being forced off, and may login again unless their allowed logins are reduced to 0 before they can attempt another login. When using the FORCELOGOUT command, the administrator must specify the connection designation (as listed with the CONNECTIONS command) of the user to be forced off. Pressing <ENTER> or typing NO at the confirmation prompt will abort the command. To execute the command, enter YES at the confirmation prompt.

```
sys admin>>FORCELOGOUT SYSADMIN
Force logout sys admin? (write out YES) Yes or No: No>yes
sys admin>>
```

The FORCELOGOUT command may also be used to disconnect a network administrator session. The qualifiers SYSADMIN must be specified after the command.

### 4.8.2 TELNETTIMEOUT Command

```
sys admin>TELNETTIMEOUT
Timeout set to 5 minutes

sys admin>TELNETTIMEOUT 0
Timeout set to 0 minutes
0 disables the timeout from occurring

sys admin>TELNETTIMEOUT 2
Timeout set to 2 minutes

sys admin>
```

The TELNETTIMEOUT command allows the administrator to define the amount of time that a telnet session may remain idle before breaking the network connection. A telnet session is considered idle if no characters are sent from the user's terminal. Once the time limit has been reached, the user will be logged out and the network connection will be broken. The connection will be broken if there is no activity at any login level (from logged out up to direct mode). This is intended to prevent a "dead" session from tying up system resources.

To display the current system value for the idle telnet session time limit, type TELNETTIMEOUT at the command prompt. To change the time limit, the command is entered in the form TELNETTIMEOUT <t>, where <t> is the time limit in whole minutes. The valid range for <t> is 0 to 30, with the default value set as 1. If the value is set to 0, then the time limit is disabled.

### 4.8.3 MODEMTIMEOUT Command

```
Sys admin>MODEMTIMEOUT
Timeout set to 5 minutes

Sys admin>MODEMTIMEOUT 0
Timeout set to 0 minutes
0 disables the timeout from occurring

Sys admin>MODEMTIMEOUT 2
Timeout set to 2 minutes

sys admin>
```

The MODEMTIMEOUT command is identical to the TELNETTIMEOUT command, but causes the automatic disconnection of idle modem card sessions. The modem card will deselect any currently selected device port channel, log the user out, and disconnect the telephone connection once the idle session time limit has been reached. Entering the time limit in whole minutes after the command sets the idle time limit. Entering a value of 0 will disable the timeout. Entering the command by itself will display the current modem idle call time limit.

## 4.9 Saving and Restoring System Settings

The administrator may save all the ConsoleServer 800 parameter settings (terminal port settings, device port settings, user IDs, etc.) and restore them later using the BACKUP and RESTORE commands. To use this feature, the administrator must be directly connected to control card port 'A' using a terminal or communications program capable of capturing the screen output from the ConsoleServer 800 to a plain ASCII file to backup the system settings, and then sending the file as plain ASCII text to the ConsoleServer 800 to restore the system settings. It is not possible to use the BACKUP and RESTORE commands from a network administrator session.

Before beginning either the backup or restore processes, make sure that there are no users logged in to the ConsoleServer 800 by using the CONNECTIONS command. If there are any users logged in, notify them to log out immediately or forcibly log them out using the FORCELOGOUT command.

Once there are no users logged in, start the backup process by beginning the screen output capture. Send the output to an ASCII file with a descriptive name (i.e., 800\_backup.log). After the screen capture is set to run, begin sending the settings by entering the command `BACKUP` at the `sys admin>` prompt. The ConsoleServer 800 will begin to output its internal records to the screen as ASCII characters in a code for ConsoleServer 800 internal use. The output may pause several times as the ConsoleServer parses the records. Once all records have been sent to the screen, the ConsoleServer 800 will return to the `sys admin>` prompt. Stop the screen capture to close the ASCII file once the prompt returns to the screen.

Do not attempt to modify or edit the text in the captured ASCII file; modifying the contents of the backup file will render the backup records invalid and unusable.

The last system records saved may be restored to the ConsoleServer 800 using the `RESTORE` command. As with the `BACKUP` command, all users must be logged out before proceeding with the `RESTORE` process. To begin, enter the command `RESTORE` at the `sys admin>` prompt. The ConsoleServer will wait for the plain ASCII file containing the system records (previously saved using the `BACKUP` command). Send the records file to the ConsoleServer 800 using the communications program's ASCII file upload function. The ConsoleServer will exit the restore process and return to the `sys admin>` prompt without altering the current system records if the wrong file is sent or if the file is somehow corrupted (i.e., through accident or attempted modification). Once the records file has been transmitted to the ConsoleServer and the restore process is complete, the ConsoleServer 800 will reboot and load the restored system settings.

#### **4.10 Changing the System Prompt**

The administrator may change the logged out system prompt for the ConsoleServer 800. The prompt may not contain the "\*" character, and can be up to 20 characters.

To change the system prompt, use the command `PROMPT`. Enter the new system prompt when indicated and press `<ENTER>`.

To change the system prompt to the default (`LCI800>`), use the command `PROMPT /DEFAULT`.



## 4.11 Updating the ConsoleServer 800 Software

As new features are added to the ConsoleServer 800, new versions of the system software will become available. The sys admin may enter the ConsoleServer 800 update mode using the command LCIUPDATE (which may never be abbreviated). It is not necessary to backup the ConsoleServer 800 system settings using the BACKUP command before performing the software update, as all settings remain the same when the update is complete. Appendix B covers the procedure for using the LCIUPDATE command. The newest version of flash software is always available at the Lightwave Communication's FTP site (<ftp://ftp.lightwavecom.com>) accessible from any web browser or FTP client.

## 5.0 User Access and Functions

### 5.1 Terminal Port

To access servers through the ConsoleServer 800 terminal port, the user must have at least a text terminal capable of serial communication, a Lightwave serial adapter and cable, and the proper serial communication settings as determined by the system administrator.

Once the hardware is properly connected and configured, the user may issue commands through the terminal port. Before entering any commands, the user should be sure that the terminal is ready to accept commands by checking that there is a prompt on screen. This is best accomplished by pressing <ENTER> until a prompt appears on the screen (a prompt will not appear on the screen if the terminal port is in direct mode, or if the serial cable is not connected properly).

### 5.2 Network Port

The network card must be connected to a network that uses TCP/IP. Devices connected to the network card must be at 10 Mbps, half duplex, and no auto-negotiation on 10-base T (Cat 5) wiring. IPv6 is not supported.

To connect to the ConsoleServer 800 network port, the user should use a TCP/IP telnet client to telnet to the IP address assigned to the network card.

```
OCTANE_65 10# TELNET 172.16.1.31
Trying 172.16.1.31...
Connected to 172.16.1.31
Escape character is '^]'.

welcome to the consoleServer 800
You are connected to Port N1 via 172.16.1.31

LCI800>
```

The user interface for the network port is the same as that for the terminal port, with a few minor exceptions. When a user first connects to the network card, the card will display welcome to the Console Server 800, the ConsoleServer 800 network session number for the connection, and the IP address of the network card. Also, if the user enters LOGOUT at the LCI800> prompt, the ConsoleServer will disconnect the network session.

The network port allows eight simultaneous user connections. If another user connection is made after the eighth user, the system will allow the telnet connection, but no system prompt will appear until a user session is available

At power-up, the network port does not respond to network connect requests until the ConsoleServer has completed its system initialization. Once the power-up sequence is complete, the network port obtains its network parameters and is ready to accept connections over the network.

### **5.3 Modem Card**

The modem card allows users to remotely access the servers attached to the ConsoleServer 800 via a dial-up connection. The modem automatically detects the connection speed, and allows connections of up to 38.4K baud. The control card must complete its start-up initialization check before a user may access the ConsoleServer 800 through the modem card.

The modem card must be installed in the ConsoleServer 800 chassis. To connect the modem card to the telephone network, insert an ordinary telephone cable (RJ11) in the jack on the modem card, and insert the other end in a telephone network jack. See section 4.5 for instructions on setting the modem initialization string.

The user interface for the modem card is identical to that found on the terminal card with the exception of one command, which is outlined below. Only one user at a time may connect to the modem card.

#### **5.3.1 Ending a Modem Session**

A user may disconnect from the modem card and automatically log out from the ConsoleServer 800 by sending the BYE command or selecting DISCONNECT MODEM from the pull-down menu. This command will work at any login level that the user may send commands to the ConsoleServer 800 (i.e., logged out, logged in, and monitor mode). When the command is received, the modem card disconnects the telephone connection, and then logs the user out from the ConsoleServer 800. This command is unique to the modem card user interface.

### **5.4 Overview of Commands**

Several levels of access are available to the user, from simple access of the ConsoleServer 800 to direct access of servers attached to the ConsoleServer 800. Many of the commands are sensitive to which level the user is in, and not all commands are available at all levels.

The first prompt the user should see after connecting to the ConsoleServer 800 is the LCI800> prompt (additional information may be on the screen as indicated in the sections above). This indicates that the user is not currently logged in and that no servers may be reached through the ConsoleServer 800. The prompt will change to reflect the level in which the user is, and in monitor mode, will indicate which server is selected.

The help screens also change according to the user's login level. There are separate help screens for a logged out user, a logged in user, and a user in monitor (a.k.a. device) mode. The user may see a complete list of available commands at any prompt by typing HELP, H, or ? and pressing <ENTER>, by pressing <F1>, or by selecting DISPLAY HELP SCREEN from a pull-down menu. To use the pull-down menu of commands available at each user level, the user may press <F2> or <CTRL>+D. By using the up and down arrow keys, the user may move the highlight bar to the desired command, and then press <ENTER> to select that command. The user may use the <F1> and <F2> keys only if the terminal or terminal emulation supports VT100 function keys. If the terminal or emulation program does not support VT100 function keys, then the user may press the <CTRL> and D key simultaneously to use the pull-down menu. To exit from a menu without selecting a command, press <ESC><ESC> or <CTRL>+C.

Pressing <CTRL>+U (the control and U key simultaneously) will erase all typed commands on the current command line back to the system prompt. Pressing <CTRL>+R retypes the last command executed and waits for the user to hit <ENTER> to execute it.

## LOGGED OUT HELP

```
F1 - Display Help Screen      (VT100 mode)
F2 - Display Pull Down Menu (VT100 mode)
TTY COMMANDS:(LOGGED OUT MODE)
LOGIN                          - Login with ID and Password
INFO                           - Display System Info
REBOOT                         - Perform a warm boot, requires root password
```

## LOGGED IN HELP

```
F1 - Display Help Screen      (VT100 mode)
F2 - Display Pull Down Menu (VT100 mode)
TTY COMMANDS: (LOGGED IN MODE)
LOGOUT,LOGOFF                  - Logout
SELECT [SERVER NAME\#]        - Select a server by name or number
DISELECT[SERVER NAME\#]       - Select a server and enter direct mode
CHANGEPSWD or PASSWD          - Change user password
CONNECTIONS                    - Display connections list
DEVLIST                        - Display installed devices list
EDITESC                        - Edit direct mode escape sequence
EDITBRK                        - Edit Break generation escape sequence
REBOOT                         - Perform a warm boot, requires root password
```

## MONITOR MODE HELP

```
F1 - Display Help Screen      (VT100 mode)
F2 - Display Pull Down Menu (VT100 mode)
TTY COMMANDS: (MONITOR MODE)
LOGOUT, LOGOFF                - Logout
SELECT [SERVER NAME\#]       - Select a server by name or number
DISELECT[SERVER NAME\#]      - Select a server and enter direct mode
EXIT                           - Deselect from a server
DEVLIST                       - Display installed devices list
TOP                           - Go to beginning of device buffer
BOTTOM                        - Go to end of device buffer
NEXT                          - Display next page of device data
PREVIOUS                      - Display previous page of device data
FORWARD [n LINES]            - Go forward n lines and display page
REVERSE [n LINES]           - Go reverse n lines and display page
CLEAR                         - Clear device buffer
DIRECT                        - Enter direct mode
BYE                           - Hang up phone line (logoff implied)
REBOOT                        - Perform a warm boot, requires root password
```

Most commands may be abbreviated to one extent or another. See Appendix E for allowed abbreviations.

## 5.5 Logging In and Changing Passwords

### F2 PULL-DOWN MENU SHOWING INITIAL MENU CHOICES

```
LOGGED OUT MENU
USER LOG IN
SYSTEM INFO
DISPLAY HELP
```

To login, the user must type LOGIN at the LCI800> prompt or select USER LOG IN from the pull-down menu. The user ID may also be entered as a command qualifier after the login command.

```
LOGGED OUT>LOGIN
Please Enter User ID user_ID
Please Enter Password ****
```

- OR -

```
LOGGED OUT>login user_ID
Please Enter Password ****
```

If using the pull-down menu or if no user ID was entered as a qualifier, the ConsoleServer 800 will prompt the user for their user ID by displaying `PLeasE EntEr UsEr ID`. At this prompt, they should type the user ID assigned to them by the system administrator. After the user has entered their ID, they will be prompted for their password when the ConsoleServer 800 displays `PLeasE EntEr PasswOrd`. On the first login, this will be a password assigned by the system administrator. The password is case sensitive, so the user must be sure to type the password exactly as it is in the system. The ConsoleServer 800 will only echo stars for each character typed at the password prompt. Once the user has entered their password, the screen will clear, and a prompt displaying their user ID will appear, indicating that the ConsoleServer 800 is ready for use. For example, a user with an ID of "GEORGE" will have a prompt of `GEORGE>` once they have logged in.

**When a user profile is created by the sys admin, the password is pre-expired. The user must change the password assigned by the sys admin before selecting a device or listening to a device port for the first time.**

To change the password, the user must use the command `CHANGEPSWD` or `PASSWD`. The ConsoleServer 800 will first prompt the user for the old password by displaying `PLeasE EntEr Old PasswOrd`. At this prompt, the user should enter the old password and press `<ENTER>`. The ConsoleServer 800 will then prompt the user for the new password by displaying the prompt `PLeasE EntEr New PasswOrd`. The user should enter the new password (which may be up to ten alphanumeric characters and is case-sensitive) at this prompt and press `<ENTER>`. After entering the new password, the user will be asked to verify the new password by the prompt `PLeasE VErify PasswOrd`. The user should enter the new password again at this prompt exactly as it was typed the first time and press `<ENTER>`. If both new password entries match, the ConsoleServer 800 will display `New passwOrd acceptEd` on the screen and return to the user prompt. If the new entries do not match, the message `New and vErify passwOrd mi smatch` is displayed, the new password is rejected, and the old password remains valid. The ConsoleServer 800 will also reject a new password if the incorrect password is entered when prompted for the old password, or if the new password is the same as the old password.

## 5.6 Logging Out

A user may logout at any time that commands may be made to the ConsoleServer 800 by typing `LOGOUT`, `LOGOFF`, or by selecting `LOGOUT` from a pull-down menu. When a user is connected to a server and they logout, the connection to that server will be broken and any other users that are listening to that session will lose their connection to that server as well.

## 5.7 Checking Connections

### CONNECTION INFO SCREEN

CONNECTION INFO		
T - TEST	00 -	User logged-in
M -	00 -	channel present
N1 -	00 -	channel present
N2 -	00 -	channel present
N3 -	00 -	channel present
N4 -	00 -	channel present
N5 -	00 -	channel present
N6 -	00 -	channel present
N7 -	00 -	channel present
N8 -	00 -	channel present

Press Any Key To Continue ....

Only one user at a time may connect to a device on the ConsoleServer 800, except when using listen mode (see Section 5.9, Listening to a Server Session for more details). Before attempting to select a device port, the user may desire to check if the device port is free. The CONNECTIONS command allows the user to list the users that are logged in, which devices they have currently selected, and which mode they are in. Users may also view this information by selecting DISPLAY CONNECTED LIST from the pull-down menu when logged in.

## 5.8 Selecting a Device Port (F2 or CTL D activates the pull down menu)

### F2 PULL-DOWN MENU TO SELECT A DEVICE PORT, PART 1

LOGGED IN MENU
CONNECT TO SERVER
DIR CONNECT TO SERVER
DISPLAY CONNECTED LIST
DISPLAY SERVER NAMES
DISPLAY ACTIVE DEVICES
LOGOUT
CHANGE PASSWORD
CHANGE DIRECT MODE ESC
CHANGE BREAK MODE ESC
DISPLAY HELP

## F2 PULL-DOWN MENU TO SELECT A DEVICE PORT, PART 2

SELECT SERVER	
01 - DEVICE_1	02 - DEVICE_2
03 - DEVICE_3	04 - DEVICE_4
05 -	06 -
07 -	08 -

To select a device port, the user must type `SELECT` along with a device port name or number, or select `CONNECT TO SERVER` from the pull down menu, and then select the device port to be connected. The user must also have permission to connect to a device port as defined by the system administrator in their user profile. For example, to connect to a server named Alpha on device port 2, the user may either type `SELECT Alpha`, `SELECT 2`, or select `CONNECT TO SERVER` and then select Alpha from the next menu that appears. If the system administrator has determined that the user does not have permission to access a server, the ConsoleServer 800 will display the message `NO ACCESS TO DEVICE CHANNEL`, and the connection will not be made.

The user may exit from their current device port first by using the `EXIT` command or selecting `EXIT FROM SERVER` from the pull-down menu to free the device port for use by other users. A user may not select a server that is already selected by another user. When a server has been selected, the prompt will change to show which server has been selected by displaying the user ID, a dash, and then the server name in the general form `USER_NAME-SERVER_NAME>`. For example, if the user GEORGE selects Alpha, the prompt would read `GEORGE-Alpha>`.

When this prompt is displayed, the user is in monitor mode. There is no direct communication between the user and the server. Any output from the server is saved to a buffer that may be accessed by the user (see Section 5.10, Using the Buffer), but the user may issue no commands to the server. If the user desires to issue commands to the server, they must enter direct mode (see Section 5.9, Direct Mode).



## 5.9 Direct Mode

### F2 PULL-DOWN MENU FOR DEVICE (A.K.A. MONITOR) MODE

DEVICE MODE MENU
ENTER DIRECT MODE
CONNECT TO SERVER
DIR CONNECT TO SERVER
DISPLAY NEXT PAGE
DISPLAY PREVIOUS PAGE
GOTO BEGINING OF BUFFER
GOTO END OF BUFFER
CLEAR BUFFER
FORWARD N LINES
REVERSE N LINES
EXIT FROM SERVER
DISPLAY CONNECTED LIST
LOGOUT
DISPLAY HELP
DISCONNECT MODEM

If a user desires to interact directly with a server rather than only monitor its output, then they must enter direct mode. To enter direct mode using the `DIRECT` command, the user must first select a device port as outlined in Section 5.8, *Selecting a Server*. Then at the prompt, the user must use the command `DIRECT` or select the command `ENTER DIRECT MODE` from the pull-down menu. The user may also select a device port and enter direct mode in one step by using the `DISELECT` command or selecting `DIR CONNECT TO SERVER` from the pull-down menu. The `DISELECT` command must have either the device port number or the name assigned to the port as the command qualifier; if using the pull-down menu, a prompt box will appear to select the device port..

The user's terminal will then be directly connected to the server, and will act as if the terminal was physically connected to the server. The ConsoleServer 800 displays the last page of the device buffer along with a system information message indicating which device port is selected as the user enters direct mode.

To escape from direct mode, the direct mode escape sequence must be used. The direct mode escape sequence is a series of two to five characters that allow the user to leave direct mode and return to monitor mode. The factory default for the direct mode escape sequence is `<ESC> A` (escape key, then uppercase "a"), but the user may change the sequence by using the command `EDITESC` or selecting `CHANGE DIRECT MODE ESC` from the pull-down menu at the user prompt. It is recommended that the user only change the escape sequence if it causes problems with the hardware or software used. It is also recommended that the user avoid combinations of the `<CTRL>` key and other keys, as these combinations are usually reserved for sending and receiving special characters

through the terminal. When the user changes the escape sequence, a window with the hexadecimal representation of the old escape sequence will appear. Pressing <ESC> to exit from the edit prompt will not work; it will add additional <ESC> characters (hexadecimal value 1B) to the direct mode escape sequence. If the user wishes to keep the old sequence, they need only to press <ENTER>. Otherwise, they should press backspace to delete the old characters, then enter the new sequence and press <ENTER>. If for some reason the selection is unacceptable, an error message will appear and the sequence will revert to the old character values.

Appendix F lists the hexadecimal codes for the ASCII character set.

## 5.10 Using the Buffer

### F2 PULL-DOWN MENU FOR DEVICE (A.K.A. MONITOR) MODE

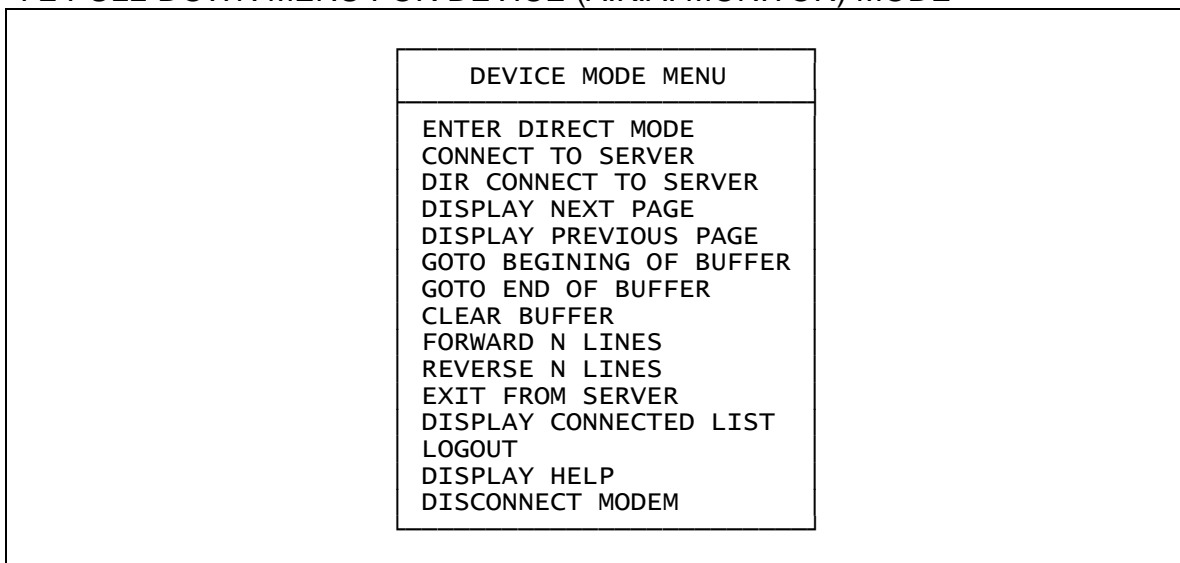

Each device port saves the output of a server to a FIFO buffer. Each buffer can store up to 64K of data, giving approximately 100 text pages. However, the actual amount of pages may vary according to the data. The user must be in monitor mode to view or clear the data stored in the buffer. Any users listening to another user's connection to a device port will see the buffer displayed as well.

```
user-DEVICE_1>TOP
```

When at the monitor mode prompt, the user may view the contents of the buffer using the commands TOP, BOTTOM, NEXT, PREVIOUS, FORWARD, and REVERSE, or by selecting the commands DISPLAY NEXT PAGE, DISPLAY PREVIOUS PAGE, GOTO BEGINNING OF BUFFER, GOTO END OF BUFFER, FORWARD N

LINES, and REVERSE N LINES from the pull down menu. The monitor mode prompt will appear at the bottom of the displayed buffer data, and the user may enter commands normally at this prompt. The prompt is prefixed with the position of the currently displayed screen in the buffer; the top of the buffer is indicated by TOP>, the bottom of the buffer is indicated as BOTTOM>, and any other position is indicated as a percentage of the total buffer (e.g., 51%>).

```

Connecting...

W.O.P.R.

LOGIN:GUEST
PASSWORD:*****

LOGIN FAILED

LOGIN:SFALKEN
PASSWORD:*****

LOGIN FAILED

LOGIN:JOSHUA

Greetings Professor Falken

How are you today?
>

TOP>usr1-DEVICE_1>

```

The following table outlines the functions of the individual commands and pull down menu items.

COMMAND	MENU ITEM	FUNCTION
TOP	GOTO BEGINNING OF BUFFER	displays first 24 lines of buffer data
BOTTOM	GOTO END OF BUFFER	displays last 24 lines of buffer data
NEXT	DISPLAY NEXT PAGE	displays next 24 lines of buffer data
PREVIOUS	DISPLAY PREVIOUS PAGE	displays previous 24 lines of buffer data
FORWARD	FORWARD N LINES	skip forward N lines in buffer
REVERSE	REVERSE N LINES	skip back N lines in buffer

The commands FORWARD and REVERSE must be followed by the number of lines the user wants to move in the buffer. The command will not execute if the number of lines is omitted.

The user may also clear the buffer by using the command CLEAR or by selecting CLEAR BUFFER from the pull-down menu. All data stored in the device buffer will be erased and is not recoverable. The sys admin may inhibit this ability on a per-user basis by either creating the user ID without this ability or editing the user parameters after the user is created.

## 5.11 The Break Generation Sequence

### F2 PULL-DOWN MENU TO CHANGE BREAK SEQUENCE

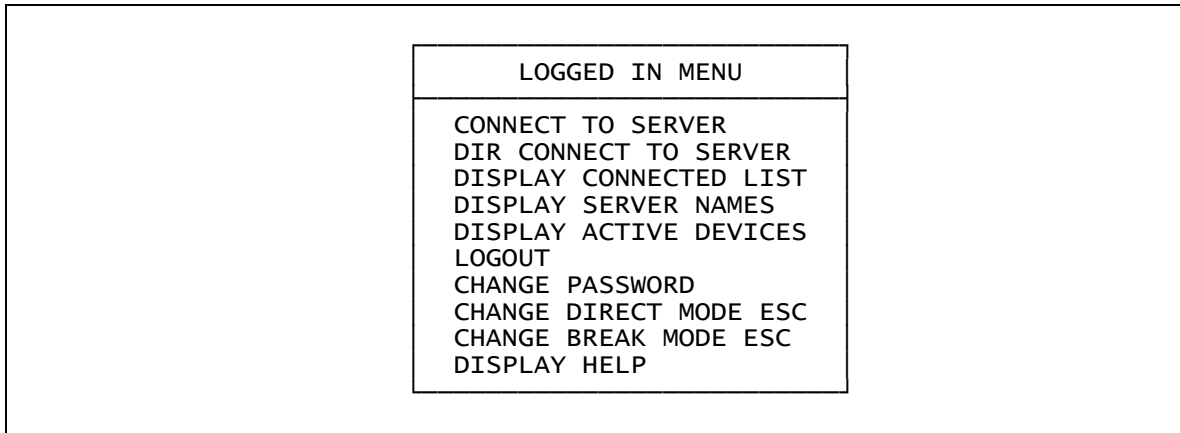

The user may find it necessary to send a break to the selected server. The break generation sequence is a two to five character sequence. The factory default break generation sequence is <ESC> B (the escape key, then uppercase "b").

The user may edit the break generation sequence in a manner similar to the direct mode escape sequence. The user may use the command EDITBRK or select CHANGE BREAK MODE ESC from the pull-down menu. It is recommended that the user only change the break generation sequence if it causes problems with the hardware or software used. It is also recommended that the user avoid combinations of the <CTRL> key and other keys, as these combinations are usually reserved for sending and receiving special characters through the terminal. When the user changes the break generation sequence, a window with the hexadecimal numerical equivalent of the old break generation sequence will appear. Pressing <ESC> to exit from the edit prompt will not work; it will add additional <ESC> characters (hexadecimal value 1B) to the break generation sequence. If the user wishes to keep the old sequence, they need only to press <ENTER>. Otherwise, they should press backspace or delete to remove the old characters, then type the new sequence and press <ENTER>. If for some reason

the selection is unacceptable, an error message will appear and the sequence will revert to the old character values.

Appendix F lists the hexadecimal codes for the ASCII character set.

## 6.0 REBOOT Command (Used only when IP addresses are changed)

```
LCI800>REBOOT
Are you sure you want to reboot? yes
Please enter root password: ****
ConsoleServer800 Boot V1.20
Copyright 2000 by Lightwave Communications, Inc. All rights reserved.
Identify Flash
Flash ID OK
verifying Flash Image
Starting system
Lightwave Communications, Inc. ConsoleServer800
Please wait...system initializing
Checking non-volatile memory...
2048
Start checking and reading stored data
Reading User Start up .....
LCI800>
```

The ConsoleServer 800 can be rebooted at any time using the command REBOOT. The system will reset, all users will be disconnected, and the power-on self-test will run. Any user may issue the REBOOT command so long as they have the administrator password.

At any ConsoleServer 800 prompt, enter the command REBOOT. The system will prompt Are you sure you want to reboot?. Enter YES to proceed, or enter NO or just hit <ENTER> to exit without rebooting. The system will then prompt for the administrator password. The ConsoleServer will only echo stars when the password is entered. If the password is correct, the system will reboot and display its power-on self-test messages. Otherwise, it will return to the same prompt present before the REBOOT command was entered.

Note that any active network sessions will disconnect while the system reboots, and no network sessions can be established while the system reboots.

## 7.0 LCD Front Panel

The LCD front panel displays various system information. At power-up, the boot code version is briefly displayed. The ConsoleServer then displays some power-on self-test information. Once the power-on self-test is complete, the active connections are displayed.

Pressing either front panel button will scroll through the available information. Pressing both buttons simultaneously scrolls through the different categories of information. The categories available are: connections, devices, network, and misc. info.

The connections category displays the name of any logged in users for each connection session. This category will also display the status of the modem card as installed or not installed.

The devices category displays the serial communication parameters for each device port. The trailing zeros for the baud rate are truncated, so a baud rate of 9600 will be displayed as 96. Parity is indicated by the first letter of the parity type (e.g., NONE is displayed as N). The status of the hardware flow control lines is indicated by a "0" or "1", where "0" indicates off and "1" indicates on. "R" indicates the RTS/CTS line, while "D" indicates the DTR/DSR line.

The network category displays the settings for the network port. The IP address, subnet mask, default gateway, and MAC address are shown.

The misc. info category displays the power supply status, the boot code and application code versions, and the terminal port settings.

If the front panel is idle (i.e., no buttons are pressed), the display will return to the connections display.

# Appendix A – Terminal Port, Device Port, and Adapter Pinouts

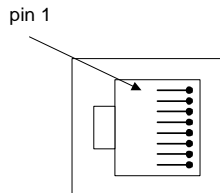
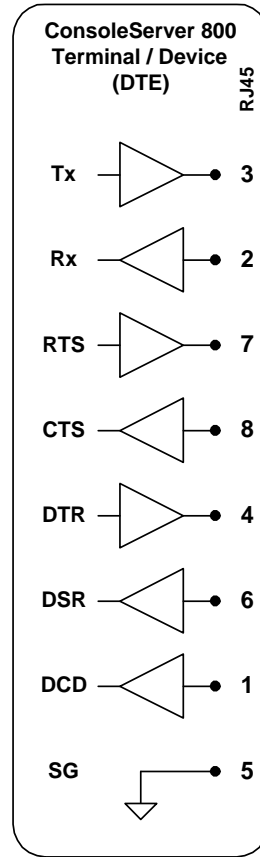
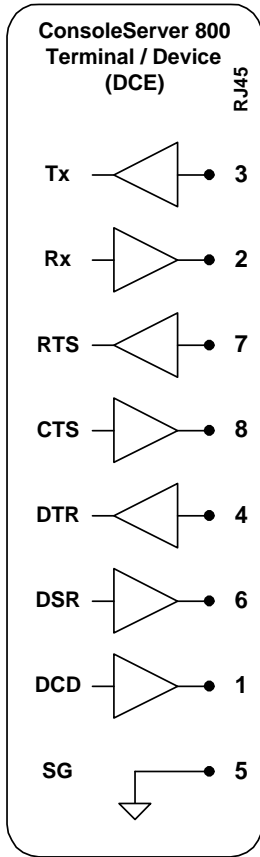

**RJ-45 Connector**

 <b>Lightwave Communications</b> <small>100 Washington Street, Milford CT 06460          800 871-9838 * Fax 203 874-0157 * www.lightwavecom.com</small>			
Title: <b>Terminal / Device RJ45 Connector Pinouts</b>			
Part Number			
Drawing Number			
Size: <b>A</b>	System: <b>ConsoleServer 800</b>	Rev: <b>A</b>	
File: <b>800_term_dev.vsd</b>	Sheet <b>01</b>	of <b>01</b>	



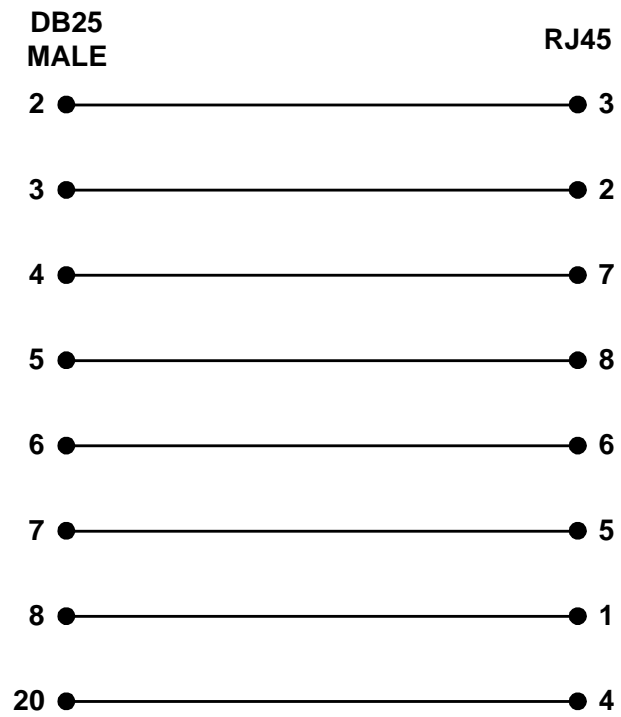
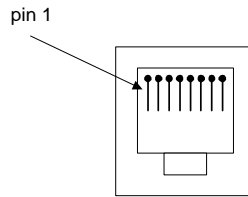

 <b>Lightwave Communications</b> <small>100 Washington Street, Milford CT 06460        800 871-9838 * Fax 203 874-0157 * www.lightwavecom.com</small>			
Title:		RJ45 Receptical to DB25M Adapter	
Part Number		200.0066	
Drawing Number		700.200.0066	
Size: A	System:	ConsoleServer 800	Rev: A
File:	200d0066.vsd	Sheet	01 of 01

pin 1

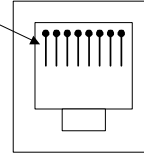

**DB25  
FEMALE**

**RJ45**

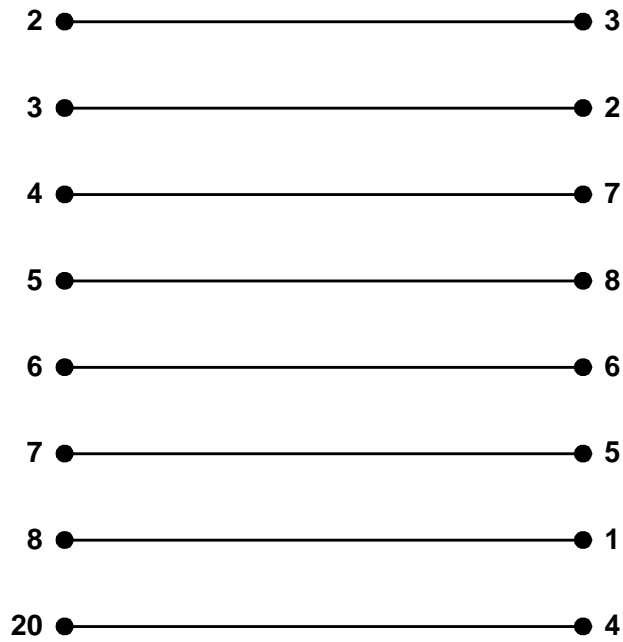

**Lightwave Communications**  
100 Washington Street, Milford CT 06460  
800 871-9838 \* Fax 203 874-0157 \* www.lightwavecom.com

Title: <b>RJ45 Receptical to DB25F Adapter</b>			
Part Number		200.0067	
Drawing Number		700.200.0067	
Size: A	System: ConsoleServer 800	Rev: A	
File: 200d0067.vsd	Sheet 01	of 01	

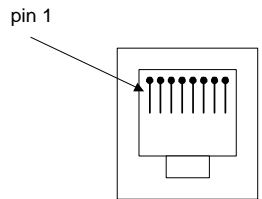

**DB9  
MALE**

**RJ45**

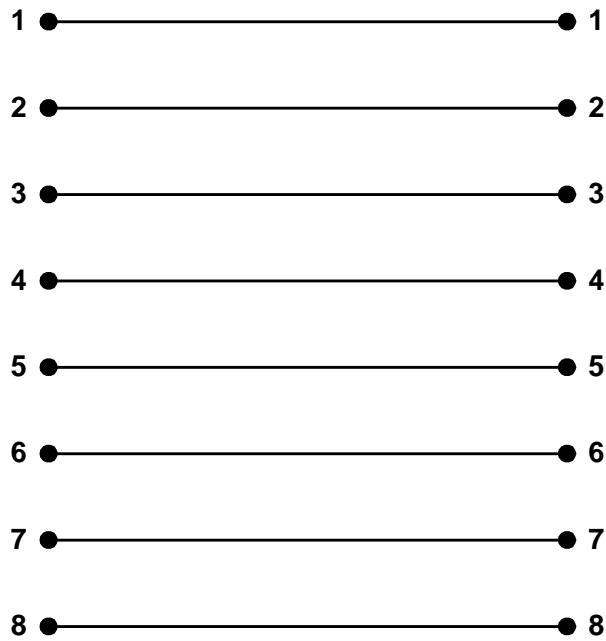

 <b>Lightwave Communications</b> <small>100 Washington Street, Milford CT 06460        800 871-9838 * Fax 203 874-0157 * www.lightwavecom.com</small>			
Title:		RJ45 Receptical to DB9M Adapter	
Part Number		200.0069	
Drawing Number		700.200.0069	
Size: A	System:	ConsoleServer 800	Rev: A
File:	200d0069.vsd	Sheet	01 of 01

pin 1

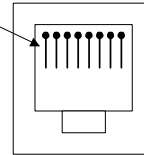

**DB9  
FEMALE**

**RJ45**

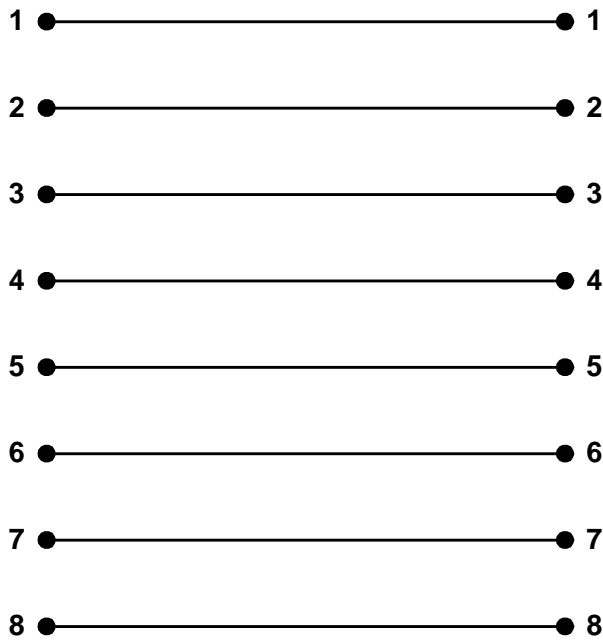

**Lightwave Communications**  
100 Washington Street, Milford CT 06460  
800 871-9838 \* Fax 203 874-0157 \* www.lightwavecom.com

Title: <b>RJ45 Receptical to DB9F Adapter</b>			
Part Number		200.0070	
Drawing Number		700.200.0070	
Size: <b>A</b>	System: <b>ConsoleServer 800</b>	Rev: <b>A</b>	
File: <b>200d0070.vsd</b>	Sheet	<b>01</b>	of <b>01</b>

## Appendix B – Flash Update Procedure

### B.1 Introduction

The system administrator can update the software held in flash memory. The flash software may be updated by two means: through a direct serial connection, or via network.

### B.2 Requirements

#### Direct Serial Connection:

- terminal or computer capable of communication with control card
- ability to upload binary files using kermit or Xmodem
- latest flash software files

#### Network Update:

- installed and configured network card
- latest flash software files
- tftp server
- network or direct serial connection to the administrator login

The latest versions of software may always be obtained at Lightwave Communications' FTP site, <ftp.lightwavecom.com>, accessible from any web browser or FTP client program. The full URL to the latest ConsoleServer 800 flash software updates, procedures and instructions is:

```
ftp://ftp.lightwavecom.com/pub/products/800/update/
```

### B.3 Getting Started

Before initiating the flash update process, it is recommended that the system administrator check that there are no active users on the ConsoleServer 800 by using the CONNECTIONS command. If there are any users logged in, they should be notified to log out immediately or forcibly logged out by using the FORCELOGOUT command.

#### B.3.1 Communications Settings

The communications settings are slightly different for the serial flash update than for the normal operation mode. The baud rate, data bits, parity, and stop bits all

remain the same between modes, but the flow control changes. In the flash update mode, the flow control changes to hardware flow control (RTS/CTS). Once the system returns to normal operating mode, software flow control (XON/XOFF) is used.

## B.4 Update over Direct Serial Connection

The terminal or computer that will be used for the flash update must be connected to the terminal port. All users must be logged out. The system administrator must log in before beginning the update. Commands that the administrator should enter and text returned by the ConsoleServer are in Lucida Console font. All commands should be followed by <ENTER>.

```
sys admin>lciupdate
Start system update, are you sure? (write out "yes") "Yes" or "No": No>yes
```

Once there are no users logged in, the system administrator must type LCIUPDATE to initiate the flash update process. The ConsoleServer will ask the system administrator if he is sure by displaying the prompt Start system update, are you sure? (write out "yes") "Yes" or "No": No>. If the system administrator wants to proceed with the update, he should type out YES completely and press <ENTER>. Otherwise, NO or just N and <ENTER> will exit the process.

```
sys admin>lciupdate
Start system update, are you sure? (write out "yes") "Yes" or "No": No>yes

ConsoleServer800 Boot V1.20
Copyright 2000 by Lightwave Communications, Inc. All rights reserved.
Identify Flash
Flash ID OK
Verifying Flash Image

Select download protocol - X for XMODEM, K for KERMIT:
```

When using XMODEM, this prompt will be followed by the letter "C", which will keep appearing on the screen, indicating the control card is ready to accept the download.

```

Received: V1.34 CS800
Continue with programming? (y/n) y

Erasing the Flash (takes about 10 sec.)
Programming
Flash.....
.....
.....
.....
Flash programming complete
Starting system
Lightwave Communications, Inc. ConsoleServer800 v1.34
Please wait...system initializing
Checking non-volatile memory...
2048
Start checking and reading stored data
Reading User Start up .....

LCI800>

```

The system administrator should begin the upload of the appropriate flash update from their computer at this point. If the system administrator wishes to continue with the update, he should type Y; otherwise to end, he should type N, which will return the system administrator to the previous flash update prompt.

If the administrator chooses to continue the update, the system will reprogram the flash and restart automatically.

## B.5 Update over Network

A flash update file download may be initiated from either a network administrator session or a local serial administrator session. In either case, no other administrator session activity is allowed while the download is in progress.

The tftp server must be specified by a numerical IP address. The file path and name on the server is specified after the IP address.

```

sys admin> tftp 172.16.1.1:CS800.bin
Starting tftp download.....
.....
.....
Download complete.
sys admin>

```

In the example above, the tftp download is from the tftp server at 172.16.1.1, and the file CS800.bin is retrieved.

```
sys admin>> lciupdate /tftp
```

Once a flash update file has been downloaded via tftp, it can be sent to the system using the LCIUPDATE command with the qualifier /TFTP. This sends the last downloaded file to the system.

## **B.6 Ending the Flash Update**

Once the flash update is completed, the ConsoleServer 800 will restart and the standard start-up messages will be displayed. Once the ConsoleServer 800 has checked the memory pages (and reset those necessary), the LCI800> prompt will be displayed and the system administrator may login. On the first log in after the flash update, it recommended that the system administrator check the software versions by using the VERSION command. Once the LCI800> prompt appears on the terminal, users may log back in and connect to servers as before the update.



## Appendix C – System Specifications

### C.1 Physical

Width:	17.25 inches (4.45 cm)
Depth:	8.00 inches (20.32 cm)
Height:	1.75 inches (4.45 cm) 1 RU
Shipping weight:	15 pounds (6.80 kg)

### C.2 Environmental

Operating temperature range:	32°F (0°C) to 125°F (52°C)
Operating humidity range:	30% to 90% RH, non-condensing
Storage temperature range:	-4°F (-20°C) to 158°F (70°C)
Storage humidity range:	10% to 90% RH, non-condensing
Heat generated in normal operation:	75.1 BTU/hour

### C.3 Electrical

Both the AC and DC power versions of the ConsoleServer feature redundant power supplies.

#### C.3.1 AC Power

Universal input voltage, auto-switched AC power supplies, switch fused

Input voltage:	110/240 VAC
AC frequency:	50/60 Hz
Maximum power consumption:	25 W
Typical power consumption:	22 W

#### C.3.2 DC Power

48 volt only, externally fused

Input voltage:	-48 VDC
Maximum power consumption:	25 W

Typical power consumption: 22 W

## **C.4 Interface**

### **C.4.1 Terminal and Device**

Connector:	RJ45 with adapters for EIA-standard connectors (DB9 and DB25)
Specification:	EIA-232
Maximum baud rate:	38400
Minimum baud rate:	9600
Maximum user sessions:	1

### **C.4.2 Network**

Connector:	RJ45
Protocol:	TCP/IP (version 4)
Maximum speed:	10 Mbits, half duplex
Auto-negotiation:	NOT SUPPORTED
Maximum user sessions:	8

### **C.4.3 Modem**

Format:	analog POTS
Maximum speed:	38400 baud
Maximum user sessions:	1

## **C.5 Compliance and Certification**

Entela Electrical Safety Certification (equivalent to UL 1950 and CSA 950)

*Entela is a USA OSHA Nationally Recognized Testing Laboratory (NRTL), an accredited Certification Organization by the Standards Council of Canada (SCC), and an IECEE – CB Scheme National Certifications Body (NCB) & Certification Body Testing Laboratory (CBTL).*

CE 55022, 55024, and 60950 (LVD)

AS/NZS 3548 (C-tick approved)

Conforms to FCC part 15, class A

Conforms to VCCI standards

## C.6 Identification of Exterior Components

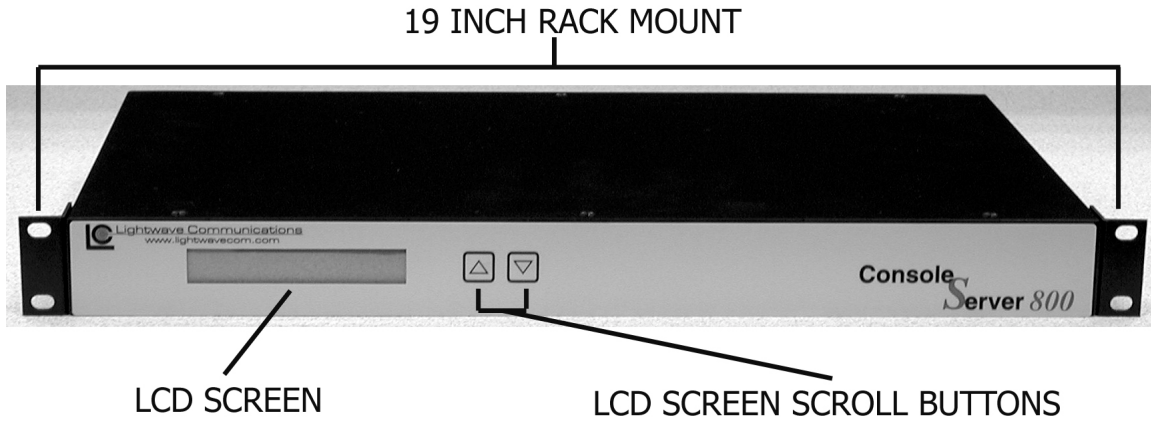

Front of ConsoleServer 800

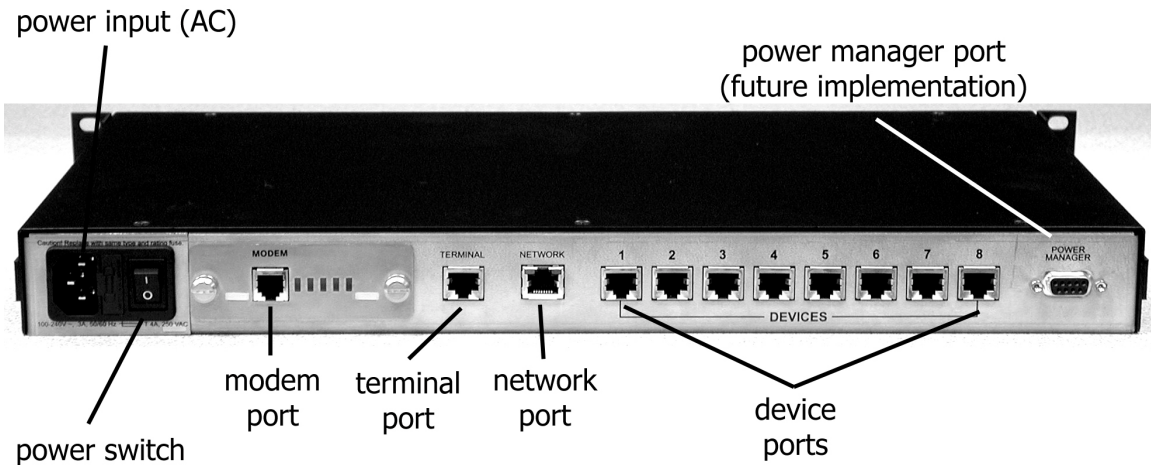

Rear of ConsoleServer 800

## Appendix D – DC Power Specifications

### D.1 DC Power Source

Input voltage:	-48 VDC
Minimum voltage:	-40 VDC
Maximum voltage:	-60 VDC
Maximum operating current:	1.5 A
Maximum input surge current:	5 A

The DC power source must be:

- electrically isolated from any AC source
- reliably connected to earth
- capable of providing up to 100 Watts of continuous power

### D.2 Overcurrent Protection

Overcurrent protection requirements:

- 10 Amp trip
  - double pole
  - fast trip
  - DC rated
- 
- Overcurrent protection devices (e.g., circuit breakers) must be provided as part of each equipment rack, and are not included with the ConsoleServer.
  - The device must be located between the DC power source and the ConsoleServer.

### D.3 DC Supply Connector

The supply input connectors are provided with each ConsoleServer. However, the conductors are not. See below for conductor specifications.

Conductor material:	copper only
Wire gauge:	16 AWG
Insulation rating:	75°C minimum, low smoke fume, flame retardant
Branch circuit cable insulation color:	per applicable national electrical codes

Grounding cable insulation color: green/yellow

The cable type should be one of the following:

- UL style 1028 or other UL 1581 (VW-1) compliant equivalent
- IEEE 383 compliant
- IEEE 1202-1991 compliant

## Appendix E – Command Abbreviations

Most, but not all, commands available on the ConsoleServer 800 may be abbreviated. The following list outlines the allowed maximum abbreviations for all commands. Command qualifiers for a command may be found immediately below that command.

Administrator Commands:

<u>command</u>	<u>abbreviation</u>
adduser	addu, au
backup	backup
changepswd	passwd, pswd
connections	c
/monitor	/m
deleteuser	deleteu
devices	dev
/all	/a
edituser	editu, eu
forcelogout	forcelogout
help	h, ?
info	info
lciupdate	lciupdate
/tftp	/tftp
linesperpage	linespp, lines, lpp
listdevices	listd, ld
listusers	listu, lu
/all	/a
login	logi
logout, logoff	lo
modem	modem
modemtimeout	modemt, mt
network	net
/edit	/e
powerstatus	po, ps
reboot	reboot
telnettimeout	telnett, tt
timeout	time
version	ver

## Terminal, Network, and Modem Commands:

<u>command</u>	<u>abbreviation</u>
bottom	bo
bye	bye
changepswd	ch
clear	cl
connections	co
devlist	de
direct	dir
diselect	dis
editbrk	editb
editesc	edite
exit	ex
forward	f
login	logi
logout, logoff	logou, logof
next	n
passwd	pa
previous	pr
reboot	reboot
reverse	r
select	se
top	t

## Appendix F – Hexadecimal ASCII Code

*Equivalent characters in italics are non-printing characters or signals.*

Hexadecimal Code	Equivalent Character
00	<i>NUL</i>
01	<i>SOH</i>
02	<i>STX</i>
03	<i>ETX</i>
04	<i>EOT</i>
05	<i>ENQ</i>
06	<i>ACK</i>
07	<i>BEL</i>
08	<i>BS</i>
09	<i>HT</i>
0A	<i>NL</i>
0B	<i>VT</i>
0C	<i>NP</i>
0D	<i>CR</i>
0E	<i>SO</i>
0F	<i>SI</i>
10	<i>DLE</i>
11	<i>DC1</i>
12	<i>DC2</i>
13	<i>DC3</i>
14	<i>DC4</i>
15	<i>NAK</i>
16	<i>SYN</i>
17	<i>ETB</i>
18	<i>CAN</i>
19	<i>EM</i>
1A	<i>SUB</i>
1B	<i>ESC</i>
1C	<i>FS</i>
1D	<i>GS</i>
1E	<i>RS</i>
1F	<i>US</i>

Hexadecimal Code	Equivalent Character
20	<i>SP</i>
21	!
22	"
23	#
24	\$
25	%
26	&
27	'
28	(
29	)
2A	*
2B	+
2C	,
2D	-
2E	.
2F	/
30	0
31	1
32	2
33	3
34	4
35	5
36	6
37	7
38	8
39	9
3A	:
3B	;
3C	<
3D	=
3E	>
3F	?



Hexadecimal Code	Equivalent Character
40	@
41	A
42	B
43	C
44	D
45	E
46	F
47	G
48	H
49	I
4A	J
4B	K
4C	L
4D	M
4E	N
4F	O
50	P
51	Q
52	R
53	S
54	T
55	U
56	V
57	W
58	X
59	Y
5A	Z
5B	[
5C	\
5D	]
5E	^
5F	_

Hexadecimal Code	Equivalent Character
60	`
61	a
62	b
63	c
64	d
65	e
66	f
67	g
68	h
69	i
6A	j
6B	k
6C	l
6D	m
6E	n
6F	o
70	p
71	q
72	r
73	s
74	t
75	u
76	v
77	w
78	x
79	y
7A	z
7B	{
7C	
7D	}
7E	~
7F	<i>DEL</i>